



# DP inox + DP inox SP10

La serie "DPG", "50DPG" e "10DPG" è composta da due tubi. La parete interna è in acciaio inox AISI 316 L (DIN 1.4404) mentre la parete esterna è in acciaio inox AISI 304 BA (DIN 1.4301). L'isolamento è composto da lana di roccia ad alta densità di spessore 25 mm per la serie DPG dal Ø80 fino al Ø350 interno, di spessore 50 mm per la serie 50DPG dal Ø350 fino al Ø500 interno ed infine di spessore 10 mm per la serie 10DPG dal Ø80 fino al Ø130 interno. La guarnizione, di tipo siliconica nera a triplo labbro, è fornita di serie dal Ø80 fino al Ø150 interno. Il sistema di giunzione è di tipo maschio/femmina, mentre il sistema di saldatura è longitudinale continuo al TIG o PLASMA. Per le serie DPG e 50DPG il sistema camino è idoneo per l'evacuazione dei fumi condensati o secchi per funzionamento in pressione negativa (N1) o positiva (P1). La temperatura max di esercizio per funzionamento in N1 è di 600° C senza guarnizione, mentre per funzionamento in P1 è di 200° C con guarnizione. Sono ammessi combustibili solidi per funzionamento a secco, liquidi e gassosi per funzionamento a umido e secco. Per la serie 10DPG il canale da fumo e condotto fumario è idoneo per l'evacuazione dei fumi condensati o secchi per funzionamento in pressione positiva (P1). La temperatura max di esercizio per funzionamento in P1 è di 200°C con guarnizione.

The "DPG", "50DPG" and "10DPG" series is composed of two pipes. The inner wall is made of AISI 316 L (DIN 1.4404) stainless steel, while the outer wall is made of AISI 304 BA (DIN 1.4301). The insulation is made of high density 25 mm thick rock wool for the DPG series from Ø80 up to Ø350 inside, while it is 50 mm thick for the 50 DPG series from Ø350 up to Ø500 inside and it is 10 mm thick for the 10DPG series from Ø80 up to Ø130 inside. The black silicone gasket is supplied as standard from Ø80 up to Ø150 inside. The joint system is of male / female type, while the welding system is longitudinal continuous to TIG or PLASMA. Concerning DPG and 50DPG series, the chimney system is suitable for the evacuation of condensed or dried smokes for operations under negative (N1) or positive (P1) pressure. The maximum operating temperature for N1 operations is 600°C without gasket, while for P1 operations is 200°C with gasket. Solid fuels are allowed for dry running; liquid and solid fuels for operations in wet and dry running. As for 10DPG series, the connecting flue pipe, such as the flue liner, are suitable for the evacuation of condensed or dried smokes for operations in positive pressure (P1). The maximum operating temperature is 200°C for P1 operation with gasket.

La série "DPG", "50DPG" et "10DPG" sont composées de deux tubes. La paroi Intérieure est en acier inoxydable AISI 316 (DIN 1.4404) tandis que la paroi Extérieure est en acier inoxydable AISI 304 BA (DIN 1.4301). L'isolation est en laine de roche haute densité 25 mm d'épaisseur pour la série DPG du Ø 80 à Ø 350 Intérieur, alors qu'il est de 50mm d'épaisseur pour la série 50DPG du Ø350 à Ø500 Intérieur et enfin de 10mm d'épaisseur pour la série 10DPG du Ø 80 à Ø 130 Intérieur. Le joint en silicone noir est fourni de série du Ø 80 jusqu'au Ø150 Intérieur. Le système de jonction est de type mâle / femelle et le soudage est longitudinal en continu au TIG ou au PLASMA. Pour la série DPG et 50DPG, le canal de fumée et même le conduit sont adaptés pour l'évacuation des condensats ou des fumées sèches aussi bien en pression positive que négative. Les températures maximales pour le fonctionnement en N1 sont de 600°C sans joint tandis qu'elles sont de 200°C pour le fonctionnement en P1 avec joint. Les combustibles gazeux et liquides sont admis pour un fonctionnement à sec ou humide. Par contre les combustibles solides nécessitent d'un fonctionnement à sec. Pour la série 10DPG, le canal de fumée et même le conduit sont adaptés pour l'évacuation des condensats ou des fumées sèches sous une pression positive (P1). La température maximale de fonctionnement en P1 est de 200°C avec joint.

\* GUARNIZIONE E FASCETTA STRINGITUBO INCLUSE / GASKET AND CLAMP INCLUDED / JOINT D'ÉTANCHÉITÉ ET COLLIER DE JONCTION COMPRIS

ARTICOLI IMBALLATI SINGOLARMENTE / ONE ITEM BOXES / ARTICLES EMBALLÉS SÉPARÉMENT

**ELEMENTO LINEARE - STRAIGHT ELEMENT - LONGUEUR DROITE**  
**FASCETTA STRINGITUBO INCLUSA / CLAMP INCLUDED / COLLIER DE JONCTION COMPRIS**

Lunghezza / Length / Longueur: 1000 mm

Cod. / Code / Réf.	Ø Interno / Internal / Intérieur	Ø Esterno / External / Extérieur
DPG80X1000	*80	130
DPG100X1000	*100	150
DPG120X1000	*120	170
DPG130X1000	*130	180
DPG140X1000	*140	190
DPG150X1000	*150	200
DPG180X1000	180	230
DPG200X1000	200	250
DPG250X1000	250	300
DPG300X1000	300	350
DPG350X1000	350	400
50DPG350X1000	350	450
50DPG400X1000	400	500
50DPG450X1000	450	550
50DPG500X1000	500	600

Lunghezza / Length / Longueur: 500 mm

DPG80X500	*80	130
DPG100X500	*100	150
DPG120X500	*120	170
DPG130X500	*130	180
DPG140X500	*140	190
DPG150X500	*150	200
DPG180X500	180	230
DPG200X500	200	250
DPG250X500	250	300
DPG300X500	300	350
DPG350X500	350	400
50DPG350X500	350	450
50DPG400X500	400	500
50DPG450X500	450	550
50DPG500X500	500	600

Lunghezza / Length / Longueur: 250 mm

DPG80X250	*80	130
DPG100X250	*100	150
DPG120X250	*120	170
DPG130X250	*130	180
DPG140X250	*140	190
DPG150X250	*150	200
DPG180X250	180	230
DPG200X250	200	250
DPG250X250	250	300
DPG300X250	300	350
DPG350X250	350	400
50DPG350X250	350	450
50DPG400X250	400	500
50DPG450X250	450	550
50DPG500X250	500	600

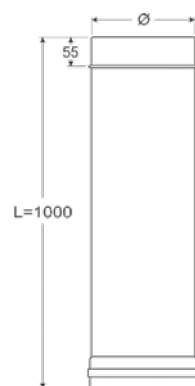

\* **Guarnizione inclusa** / Gasket included / Joint d'étanchéité compris  
 \*\* **Quotazioni su richiesta** / Quotations upon request / Devis sur demande



**ELEMENTO TELESCOPICO (mm 480 X 740) - ADJUSTABLE PIPE - LONGUEUR DROITE AJUSTABLE**

Cod. / Code / Réf.	Ø Interno / Internal / Intérieur	Ø Esterno / External / Extérieur
DPGTEL80	*80	130
DPGTEL100	*100	150
DPGTEL120	*120	170
DPGTEL130	*130	180
DPGTEL140	*140	190
DPGTEL150	*150	200
DPGTEL180	180	230
DPGTEL200	200	250
DPGTEL250	250	300
DPGTEL300	300	350
DPGTEL350	350	400
50DPGTEL350	350	450
50DPGTEL400	400	500
50DPGTEL450	450	550
50DPGTEL500	500	600

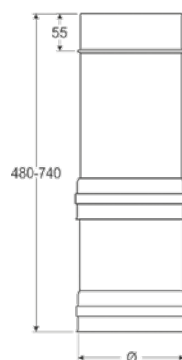

Diametri maggiori su richiesta - Bigger diameters upon request - Diamètres plus grand sur demande

**CURVA 30° - 30° ELBOW - COUDE À 30°**

Cod. / Code / Réf.	H	H1	H2	D	D1	N° SET	Ø Int. / Inte. / Intér.	Ø Est. / Exte. / Extér.
DPGC80/30	143	208	303	47	66	2	*80	130
DPGC100/30	142	217	311	48	69	2	*100	150
DPGC120/30	152	237	324	52	76	2	*120	170
DPGC130/30	141	231	324	50	72	2	*130	180
DPGC140/30	143	238	333	51	74	2	*140	190
DPGC150/30	162	262	377	57	86	2	*150	200
DPGC180/30	136	251	340	53	76	2	180	230
DPGC200/30	150	275	378	57	86	2	200	250
DPGC250/30	139	289	380	57	87	2	250	300
DPGC300/30	144	319	415	62	96	2	300	350
DPGC350/30	142	342	436	65	102	2	350	400
50DPGC350/30	142	367	461	68	109	2	350	450
50DPGC400/30	144	394	490	72	116	2	400	500
50DPGC450/30	144	419	515	75	123	2	450	550
50DPGC500/30	144	444	542	79	131	2	500	600

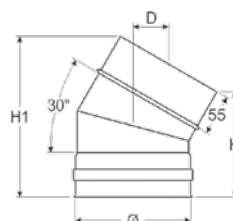
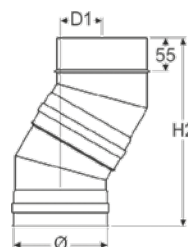

**CURVA 45° - 45° ELBOW - COUDE À 45°**

Cod. / Code / Réf.	H	H1	H2	D	D1	N° SET	Ø Int. / Inte. / Intér.	Ø Est. / Exte. / Extér.
DPGC80/45	128	220	309	72	105	2	*80	130
DPGC100/45	132	238	332	77	115	2	*100	150
DPGC120/45	137	257	354	81	124	2	*120	170
DPGC130/45	137	264	362	83	127	2	*130	180
DPGC140/45	137	271	369	84	130	2	*140	190
DPGC150/45	133	275	369	84	130	2	*150	200
DPGC180/45	137	299	397	90	142	2	180	230
DPGC200/45	130	308	401	91	143	2	200	250
DPGC250/45	137	349	446	100	162	2	250	300
DPGC300/45	137	384	482	108	177	2	300	350
DPGC350/45	227	510	698	153	266	3	350	400
50DPGC350/45	224	542	727	159	278	3	350	450
50DPGC400/45	224	577	762	166	293	3	400	500
50DPGC450/45	224	613	797	173	307	3	450	550
50DPGC500/45	262	686	909	196	354	4	500	600

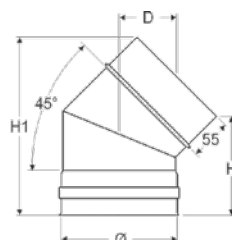
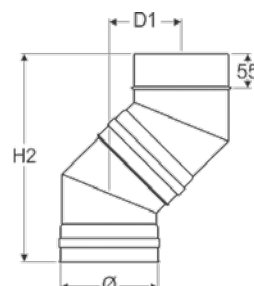

DP INOX +  
DP INOX SP10

**CURVA 90° - 90° ELBOW - COUDE À 90°**

Cod. / Code / Réf.	H	H1	D	N° SET	Ø Int. / Inte. /Intér.	Ø Est. / Exte. / Extér.
DPGC80/90	237	344	289	3	*80	130
DPGC100/90	243	337	282	3	*100	150
DPGC120/90	270	369	314	3	*120	170
DPGC130/90	269	359	304	3	*130	180
DPGC140/90	283	377	322	3	*140	190
DPGC150/90	298	396	341	3	*150	200
DPGC180/90	322	415	360	3	180	230
DPGC200/90	346	443	388	3	200	250
DPGC250/90	396	493	438	3	250	300
DPGC300/90	461	572	517	4	300	350
DPGC350/90	553	706	651	4	350	400
50DPGC350/90	642	833	778	5	350	450
50DPGC400/90	715	929	875	5	400	500
50DPGC450/90	756	961	906	5	450	550
50DPGC500/90	785	971	916	5	500	600

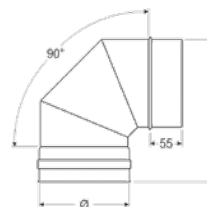
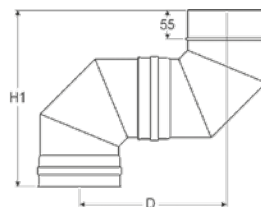

**CURVA 90° CON ISPEZIONE - 90° ELBOW WITH INSPECTION DOOR - COUDE À 90° AVEC TRAPPE DE VISITE**

Cod. / Code / Réf.	H	Øi	N° SET	Ø Int. / Inte. /Intér.	Ø Est. / Exte. / Extér.
DPGC80/90ISP	237	80	3	*80	130
DPGC100/90ISP	243	80	3	*100	150
DPGC120/90ISP	270	80	3	*120	170
DPGC130/90ISP	269	80	3	*130	180
DPGC140/90ISP	283	80	3	*140	190
DPGC150/90ISP	298	80	3	*150	200
DPGC180/90ISP	322	150	3	180	230
DPGC200/90ISP	346	150	3	200	250
DPGC250/90ISP	396	150	3	250	300
DPGC300/90ISP	461	150	4	300	350

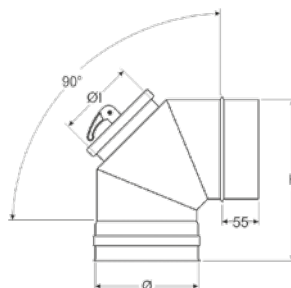

**T 90° CON ISPEZIONE - 90° TEE WITH INSPECTION DOOR - TÉ À 90° AVEC TRAPPE DE VISITE**

Cod. / Code / Réf.	H	H1	Øi	Ø Int. / Inte. /Intér.	Ø Est. / Exte. / Extér.
DPGT80/90ISP	310	155	80	*80	130
DPGT100/90ISP	320	160	80	*100	150
DPGT120/90ISP	400	200	80	*120	170
DPGT130/90ISP	500	250	80	*130	180
DPGT140/90ISP	500	250	100	*140	190
DPGT150/90ISP	500	250	100	*150	200
DPGT180/90ISP	500	250	150	180	230
DPGT200/90ISP	500	250	150	200	250
DPGT250/90ISP	500	250	150	250	300
DPGT300/90ISP	500	250	200	300	350

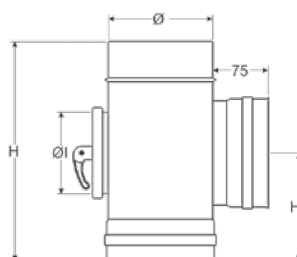

**T 90° - 90° TEE - TÉ À 90°**

Cod. / Code / Réf.	H	H1	Ø Int. / Inte. /Intér.	Ø Est. / Exte. / Extér.
DPGT80/90	310	155	*80	130
DPGT100/90	320	160	*100	150
DPGT120/90	400	200	*120	170
DPGT130/90	500	250	*130	180
DPGT140/90	500	250	*140	190
DPGT150/90	500	250	*150	200
DPGT180/90	500	250	180	230
DPGT200/90	500	250	200	250
DPGT250/90	500	250	250	300
DPGT300/90	500	250	300	350
DPGT350/90	600	300	350	400
50DPGT350/90	800	400	350	450
50DPGT400/90	800	400	400	500
50DPGT450/90	800	400	450	550
50DPGT500/90	960	480	500	600

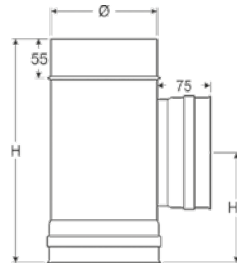

**T 90° CON ATTACCO LATERALE RIDOTTO A Ø80-130 (DOPPIA PARETE) - 90° REDUCING TEE TO Ø 80-130 (DOUBLE WALL) - TÉ À 90° REDUIT Ø 80-130 (DOUBLE PAROI)**

Cod. / Code / Réf.	Ø Int. / Inte. /Intér.	Ø Est. / Exte. / Extér.
DPGTR100-80	*100	150
DPGTR120-80	*120	170
DPGTR130-80	*130	180
DPGTR140-80	*140	190
DPGTR150-80	*150	200
DPGTR180-80	180	230
DPGTR200-80	200	250
DPGTR250-80	250	300
DPGTR300-80	300	350

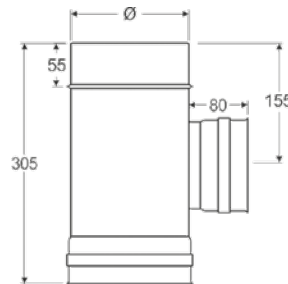

**T 90° CON ATTACCO LATERALE RIDOTTO A Ø80 (MONO PARETE) - 90° REDUCING TEE TO Ø 80 (SINGLE WALL) - TÉ À 90° REDUIT Ø 80 (SIMPLE PAROI)**

Cod. / Code / Réf.	Ø Int. / Inte. /Intér.	Ø Est. / Exte. / Extér.
DPGTR100-80MP	*100	150
DPGTR120-80MP	*120	170
DPGTR130-80MP	*130	180
DPGTR140-80MP	*140	190
DPGTR150-80MP	*150	200
DPGTR180-80MP	180	230
DPGTR200-80MP	200	250
DPGTR250-80MP	250	300
DPGTR300-80MP	300	350

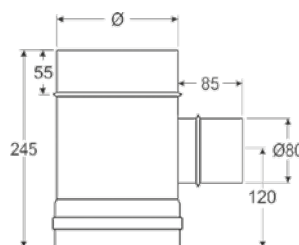

**Diametri maggiori su richiesta. Specificare M o F - Bigger diameters upon request. Indicate M or F - Diamètres plus grands sur demande. Indiquer si M ou F**

**T 135° - 135° TEE - TÈ À 135°**

Cod. / Code / Réf.	H	H1	D	DO	HO	DV	HV	Ø Int. / Inte. / Intér.	Ø Est. / Exte. / Extér.
DPGT80/135	435	120	209	344	414	241	451	*80	130
DPGT100/135	463	127	226	373	450	263	484	*100	150
DPGT120/135	491	134	243	400	485	285	516	*120	170
DPGT130/135	506	138	252	413	503	295	530	*130	180
DPGT140/135	520	141	260	425	520	305	544	*140	190
DPGT150/135	534	145	269	432	535	313	553	*150	200
DPGT180/135	615	168	301	480	614	352	626	180	230
DPGT200/135	645	175	318	499	647	370	651	200	250
DPGT250/135	715	193	361	565	734	432	727	250	300
DPGT300/135	786	210	403	625	820	472	797	300	350
DPGT350/135	750	159	416	745	904	529	920	350	400
50DPGT350/135	980	218	497	841	1107	617	1106	350	450
50DPGT400/135	980	204	537	898	1153	663	1138	400	500
50DPGT450/135	980	186	579	958	1203	713	1173	450	550
50DPGT500/135	1200	281	618	1053	1376	776	1353	500	600

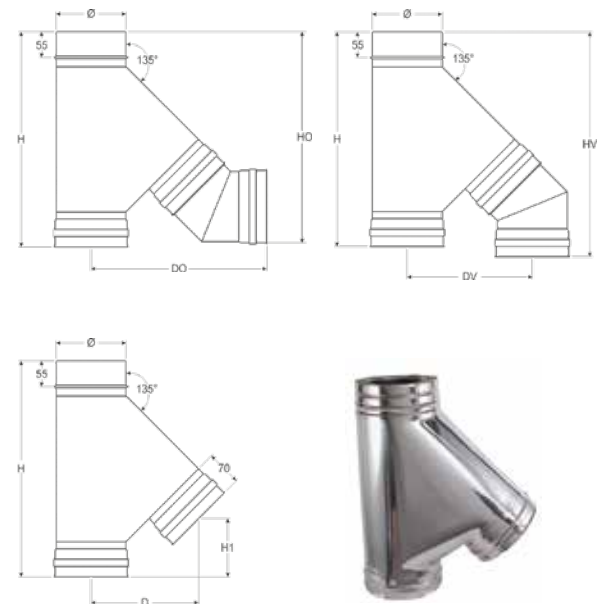

**RACCORDO MONO/DOPPIA - SINGLE/DOUBLE WALL ADAPTER - RACCORD SIMPLE/DOUBLE PAROI**

Cod. Maschio / Male code / Réf. Mâle	Cod. Femmina / Female / Femelle	H	Ø Int. / Inte. / Intér.	Ø Est. / Exte. / Extér.
DPGDM80M	DPGDM80F	170	*80	130
DPGDM100M	DPGDM100F	170	*100	150
DPGDM120M	DPGDM120F	170	*120	170
DPGDM130M	DPGDM130F	170	*130	180
DPGDM140M	DPGDM140F	170	*140	190
DPGDM150M	DPGDM150F	170	*150	200
DPGDM180M	DPGDM180F	170	180	230
DPGDM200M	DPGDM200F	170	200	250
DPGDM250M	DPGDM250F	170	250	300
DPGDM300M	DPGDM300F	170	300	350
DPGDM350M	DPGDM350F	170	350	400
50DPGDM350M	50DPGDM350F	250	350	450
50DPGDM400M	50DPGDM400F	250	400	500
50DPGDM450M	50DPGDM450F	250	450	550
50DPGDM500M	50DPGDM500F	250	500	600

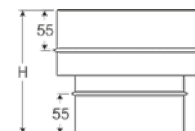
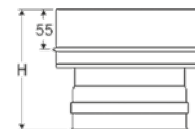

**RACCORDO DOPPIA/MONO - DOUBLE/SINGLE WALL ADAPTER - RACCORD DOUBLE/SIMPLE PAROI**

Cod. Maschio / Male code / Réf. Mâle	Cod. Femmina / Female / Femelle	H	Ø Int. / Inte. / Intér.	Ø Est. / Exte. / Extér.
DPGMD80M	DPGMD80F	170	*80	130
DPGMD100M	DPGMD100F	170	*100	150
DPGMD120M	DPGMD120F	170	*120	170
DPGMD130M	DPGMD130F	170	*130	180
DPGMD140M	DPGMD140F	170	*140	190
DPGMD150M	DPGMD150F	170	*150	200
DPGMD180M	DPGMD180F	170	180	230
DPGMD200M	DPGMD200F	170	200	250
DPGMD250M	DPGMD250F	170	250	300
DPGMD300M	DPGMD300F	170	300	350
DPGMD350M	DPGMD350F	170	350	400
50DPGMD350M	50DPGMD350F	250	350	450
50DPGMD400M	50DPGMD400F	250	400	500
50DPGMD450M	50DPGMD450F	250	450	550
50DPGMD500M	50DPGMD500F	250	500	600

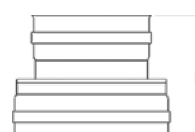
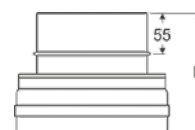

**MODULO DI ISPEZIONE CON TAPPO TONDO - ELEMENT WITH ROUND INSPECTION DOOR - ÉLÉMENT AVEC TRAPPE DE VISITE RONDE**

Cod. / Code / Réf.	H	Øi	Ø Int. / Inte. /Intér.	Ø Est. / Exte. / Extér.
DPGISP80/90	245	80	*80	130
DPGISP100/90	245	80	*100	150
DPGISP120/90	305	120	*120	170
DPGISP130/90	305	130	*130	180
DPGISP140/90	315	140	*140	190
DPGISP150/90	315	150	*150	200
DPGISP180/90	495	180	180	230
DPGISP200/90	495	200	200	250
DPGISP250/90	495	200	250	300
DPGISP300/90	495	250	300	350
DPGISP350/90	495	250	350	400
50DPGISP350/90	495	250	350	450
50DPGISP400/90	495	250	400	500
50DPGISP450/90	495	250	450	550
50DPGISP500/90	495	250	500	600

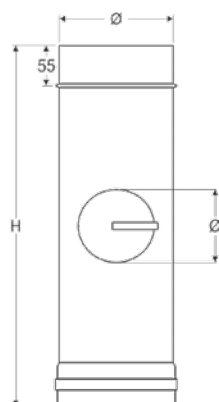

**MODULO DI ISPEZIONE CON TAPPO TONDO PER ALTE TEMPERATURE - ELEMENT WITH ROUND INSPECTION DOOR FOR HIGH TEMPERATURES - ÉLÉMENT AVEC TRAPPE DE VISITE RONDE POUR TEMPÉRATURES ÉLEVÉES**

Cod. / Code / Réf.	H	Øi	Ø Int. / Inte. /Intér.	Ø Est. / Exte. / Extér.
DPGISP80/90HT	245	80	80	130
DPGISP100/90HT	245	80	100	150
DPGISP120/90HT	305	120	120	170
DPGISP130/90HT	305	130	130	180
DPGISP140/90HT	315	140	140	190
DPGISP150/90HT	315	150	150	200
DPGISP180/90HT	495	180	180	230
DPGISP200/90HT	495	200	200	250
DPGISP250/90HT	495	200	250	300
DPGISP300/90HT	495	250	300	350
DPGISP350/90HT	495	250	350	400
50DPGISP350/90HT	495	250	350	450
50DPGISP400/90HT	495	250	400	500
50DPGISP450/90HT	495	250	450	550
50DPGISP500/90HT	495	250	500	600

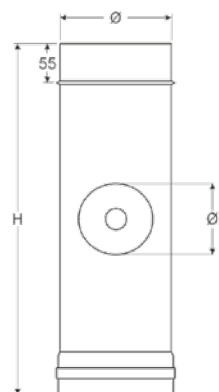

**MODULO PRELIEVO FUMI E TEMPERATURA - ELEMENT FOR SMOKES AND TEMPERATURE CHECK - PRÉLÈVEMENT FUMÉE ET TEMPÉRATURE**

Cod. / Code / Réf.	Ø Int. / Inte. /Intér.	Ø Est. / Exte. / Extér.
DPGPFT80	*80	130
DPGPFT100	*100	150
DPGPFT120	*120	170
DPGPFT130	*130	180
DPGPFT140	*140	190
DPGPFT150	*150	200
DPGPFT180	180	230
DPGPFT200	200	250
DPGPFT250	250	300
DPGPFT300	300	350
DPGPFT350	350	400
50DPGPFT350	350	450
50DPGPFT400	400	500
50DPGPFT450	450	550
50DPGPFT500	500	600

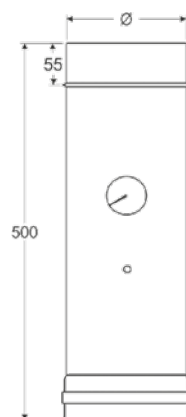

DP INOX +  
DP INOX SP10



## SUPPORTO A MURO - WALL SUPPORT - SUPPORT MURAL

Cod. / Code / Réf.	Ø Int. / Inte. /Intér.	Ø Est. / Exte. / Extér.
DPGSMU80	*80	130
DPGSMU100	*100	150
DPGSMU120	*120	170
DPGSMU130	*130	180
DPGSMU140	*140	190
DPGSMU150	*150	200
DPGSMU180	180	230
DPGSMU200	200	250
DPGSMU250	250	300
DPGSMU300	300	350
DPGSMU350	350	400
50DPGSMU350	350	450
50DPGSMU400	400	500
50DPGSMU450	450	550
50DPGSMU500	500	600

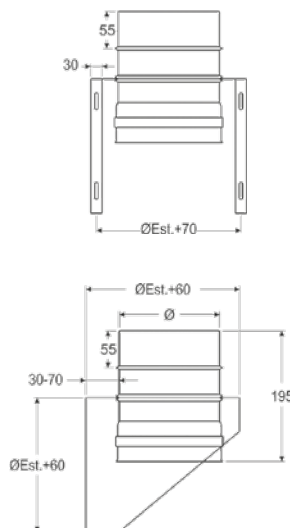

## ATTRAVERSAMENTO SOLAIO - INTERMEDIATE ANCHOR PLATE - MODULE DE TRAVERSEMENT DE SOL

Cod. / Code / Réf.	Ø Int. / Inte. /Intér.	Ø Est. / Exte. / Extér.
DPGSOL80	*80	130
DPGSOL100	*100	150
DPGSOL120	*120	170
DPGSOL130	*130	180
DPGSOL140	*140	190
DPGSOL150	*150	200
DPGSOL180	180	230
DPGSOL200	200	250
DPGSOL250	250	300
DPGSOL300	300	350
DPGSOL350	350	400
50DPGSOL350	350	450
50DPGSOL400	400	500
50DPGSOL450	450	550
50DPGSOL500	500	600

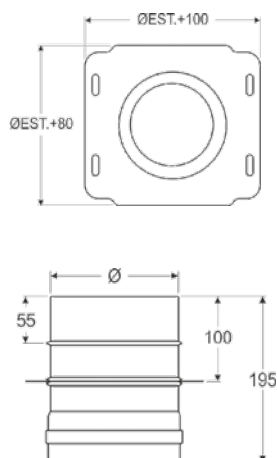

## RACCOGLI CONDENSA - DRAIN PLUG - BOUCHON DE CONDENSATION

Cod. / Code / Réf.	Ø Int. / Inte. /Intér.	Ø Est. / Exte. / Extér.
DPGRC80	*80	130
DPGRC100	*100	150
DPGRC120	*120	170
DPGRC130	*130	180
DPGRC140	*140	190
DPGRC150	*150	200
DPGRC180	180	230
DPGRC200	200	250
DPGRC250	250	300
DPGRC300	300	350
DPGRC350	350	400
50DPGRC350	350	450
50DPGRC400	400	500
50DPGRC450	450	550
50DPGRC500	500	600

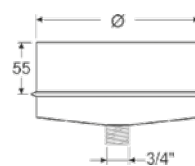

**TAPPO CON MANIGLIA - DRAIN PLUG WITH HANDLE - BOUCHON DE CONDENSATION ÉTANCHE**

Cod. / Code / Réf.	Ø Int. / Inte. /Intér.	Ø Est. / Exte. / Extér.
DPGMAN80	*80	130
DPGMAN100	*100	150
DPGMAN120	*120	170
DPGMAN130	*130	180
DPGMAN140	*140	190
DPGMAN150	*150	200
DPGMAN180	180	230
DPGMAN200	200	250
DPGMAN250	250	300
DPGMAN300	300	350
DPGMAN350	350	400
50DPGMAN350	350	450
50DPGMAN400	400	500
50DPGMAN450	450	550
50DPGMAN500	500	600

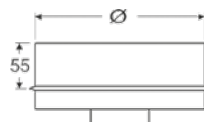

**RACCOGLI CONDENSA PER COLLETTORE - LATERAL DRAIN PLUG - BOUCHON DE CONDENSATION AVEC ÉVACUATION LATÉRALE**

Cod. / Code / Réf.	Ø Int. / Inte. /Intér.	Ø Est. / Exte. / Extér.
DPGRC80COL	*80	130
DPGRC100COL	*100	150
DPGRC120COL	*120	170
DPGRC130COL	*130	180
DPGRC140COL	*140	190
DPGRC150COL	*150	200
DPGRC180COL	180	230
DPGRC200COL	200	250
DPGRC250COL	250	300
DPGRC300COL	300	350
DPGRC350COL	350	400

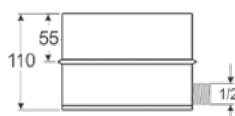

**BASE DI PARTENZA CON SCARICO LATERALE - BASE PLATE WITH LATERAL DRAIN - PLAQUE DE DÉPART AVEC ÉVACUATION LATÉRALE**

Cod. / Code / Réf.	H	Ø Int. / Inte. /Intér.	Ø Est. / Exte. / Extér.
DPGRCL80	170	*80	130
DPGRCL100	170	*100	150
DPGRCL120	170	*120	170
DPGRCL130	170	*130	180
DPGRCL140	170	*140	190
DPGRCL150	170	*150	200
DPGRCL180	170	180	230
DPGRCL200	170	200	250
DPGRCL250	170	250	300
DPGRCL300	170	300	350
DPGRCL350	240	350	400
50DPGRCL350	240	350	450
50DPGRCL400	240	400	500
50DPGRCL450	240	450	550
50DPGRCL500	240	500	600

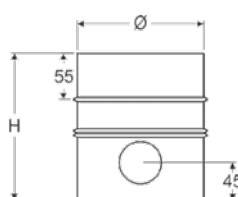
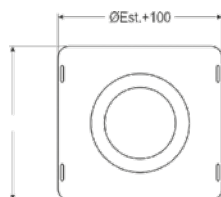

DP INOX +  
DP INOX SP10

## COMIGNOLO CINESE - CHINESE CAP - CHAPEAU CHINOIS

Cod. / Code / Réf.	H	A	He	Ø Int. / Inte. /Intér.	Ø Est. / Exte. /Extér.
DPGCIN80	195	265	70	80	130
DPGCIN100	200	265	75	100	150
DPGCIN120	215	320	90	120	170
DPGCIN130	215	320	90	130	180
DPGCIN140	225	320	100	140	190
DPGCIN150	225	320	100	150	200
DPGCIN180	250	400	110	180	230
DPGCIN200	250	400	125	200	250
DPGCIN250	275	500	150	250	300
DPGCIN300	300	600	175	300	350
DPGCIN350	320	600	200	350	400
50DPGCIN350	220	530	100	350	450
50DPGCIN400	220	580	100	400	500
50DPGCIN450	220	630	100	450	550
50DPGCIN500	220	680	100	500	600

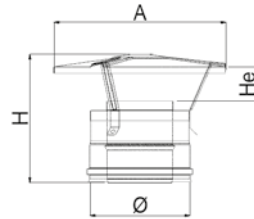

FASCETTA NON INCLUSA - Clamp not included - Collier de jonction pas compris

## COMIGNOLO ANTIVENTO - WINDPROOF CAP - CHAPEAU ANTI-INTEMPÉRIE

Cod. / Code / Réf.	H	A	Hf	Ø Int. / Inte. /Intér.	Ø Est. / Exte. /Extér.
DPGAV80	240	220	165	80	130
DPGAV100	260	260	200	100	150
DPGAV120	280	300	200	120	170
DPGAV130	280	300	200	130	180
DPGAV140	320	310	250	140	190
DPGAV150	320	310	250	150	200
DPGAV180	340	370	250	180	230
DPGAV200	340	420	250	200	250
DPGAV250	400	470	310	250	300
DPGAV300	400	530	310	300	350
DPGAV350	400	610	310	350	400
50DPGAV350	400	650	310	350	450
50DPGAV400	400	700	310	400	500
50DPGAV450	400	750	310	450	550
50DPGAV500	400	800	310	500	600

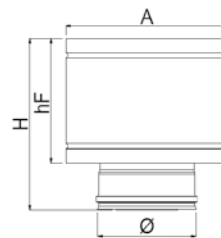

FASCETTA NON INCLUSA - Clamp not included - Collier de jonction pas compris

## COMIGNOLO TORRINO - TOWER CAP - CHAPEAU DONJON

Cod. / Code / Réf.	H	N° CONI	Ø Int. / Inte. /Intér.	Ø Est. / Exte. /Extér.
DPGTOR80	330	3	80	130
DPGTOR100	330	3	100	150
DPGTOR120	330	3	120	170
DPGTOR130	330	3	130	180
DPGTOR140	330	3	140	190
DPGTOR150	330	3	150	200
DPGTOR180	390	4	180	230
DPGTOR200	390	4	200	250
DPGTOR250	390	4	250	300
DPGTOR300	390	5	300	350
DPGTOR350	390	5	350	400

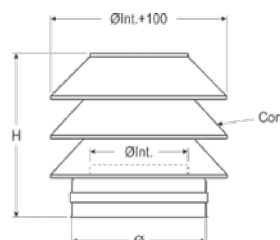

FASCETTA NON INCLUSA - Clamp not included - Collier de jonction pas compris

## COMIGNOLO TRONCO-CONICO - CONE TERMINAL - CÔNE DE FINITION

Cod. / Code / Réf.	Ø Int. / Inte. /Intér.	Ø Est. / Exte. / Extér.
DPGTC80	80	130
DPGTC100	100	150
DPGTC120	120	170
DPGTC130	130	180
DPGTC140	140	190
DPGTC150	150	200
DPGTC180	180	230
DPGTC200	200	250
DPGTC250	250	300
DPGTC300	300	350
DPGTC350	350	400
50DPGTC350	350	450
50DPGTC400	400	500
50DPGTC450	450	550
50DPGTC500	500	600

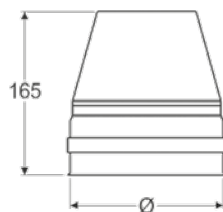

**FASCETTA NON INCLUSA** - Clamp not included - Collier de jonction pas compris

## COMIGNOLO ANTIPIOGGIA - WATERPROOF CAP - CHAPEAU ANTI-PLUIE

Cod. / Code / Réf.	H	A	Hu	Ø Int. / Inte. /Intér.	Ø Est. / Exte. / Extér.
DPGAP80	220	200	115	80	130
DPGAP100	220	200	115	100	150
DPGAP120	nd.	nd.	nd.	120	170
DPGAP130	285	300	180	130	180
DPGAP140	nd.	nd.	nd.	140	190
DPGAP150	315	350	210	150	200
DPGAP180	350	450	245	180	230
DPGAP200	350	450	245	200	250
DPGAP250	410	560	305	250	300
DPGAP300	470	680	365	300	350

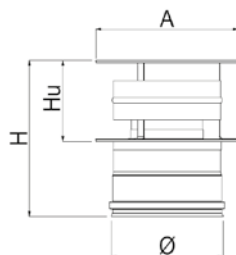

**FASCETTA NON INCLUSA** - Clamp not included - Collier de jonction pas compris

## COMIGNOLO EOLICO - AEOLIAN CAP - CHAPEAU ÉOLIEN

Cod. Femmina / Female code / Réf. Femelle	Ø
EO80DPI	80
EO100DPI	100
EO120DPI	120
EO130DPI	130
EO140DPI	140
EO150DPI	150
EO180DPI	180
EO200DPI	200
EO250DPI	250
EO300DPI	300
EO350DPI	350

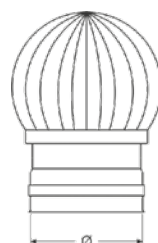

DP INOX +  
DP INOX SP10



**TERMINALE ORIZZONTALE DOPPIA PARETE - DOUBLE WALL HORIZONTAL ENDING PART - TERMINAL HORIZONTAL À BEC DOUBLE PAROI**

Cod. / Code / Réf.	L	Ø Int. / Inte. /Intér.	Ø Est. / Exte. / Extér.
DPGT080	187	80	130
DPGT0100	202	100	150
DPGT0120	220	120	170
DPGT0130	225	130	180
DPGT0140	235	140	190
DPGT0150	240	150	200
DPGT0180	262	180	230
DPGT0200	277	200	250
DPGT0250	315	250	300
DPGT0300	352	300	350
DPGT0350	389	350	400

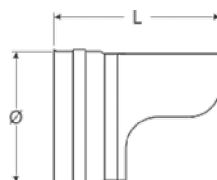

**FASCETTA NON INCLUSA** - Clamp not included - Collier de jonction pas compris

**STAFFA DI FISSAGGIO A PARETE REGOLABILE DA 50 A 80 mm - ADJUSTABLE WALL BRACKET FROM 50 TO 80 mm - COLLIER DE FIXATION MURAL RÉGLABLE DE 50 À 80 mm**

Cod. / Code / Réf.	Ø	A	B	D
MPS130	130	130	70	50-80
MPS150	150	148	86	50-80
MPS170	170	165	104	50-80
MPS180	180	172	110	50-80
MPS190	190	177	112	50-80
MPS200	200	185	121	50-80
MPS230	230	205	129	50-80
MPS250	250	220	155	50-80
MPS300	300	253	190	50-80
MPS350	350	290	228	50-80
MPS400	400	330	230	50-80
MPS450	450	360	296	50-80
MPS500	500	390	290	50-80
MPS550	550	440	340	50
MPS600	600	490	390	50

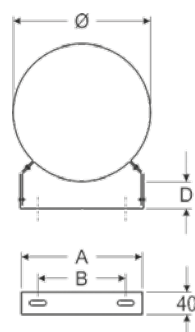

**STAFFA DI FISSAGGIO A PARETE REGOLABILE DA 10 A 150 mm - ADJUSTABLE WALL BRACKET FROM 10 TO 150 mm - COLLIER DE FIXATION MURAL RÉGLABLE DE 10 À 150 mm**

Cod. / Code / Réf.	Ø	A	B
MPSREG130	130	180	117
MPSREG150	150	200	134
MPSREG170	170	220	135
MPSREG180	180	230	170
MPSREG190	190	240	176
MPSREG200	200	250	179
MPSREG230	230	280	195
MPSREG250	250	300	175
MPSREG300	300	350	245
MPSREG350	350	400	320
MPSREG400	400	450	376
MPSREG450	450	500	424
MPSREG500	500	550	427
MPSREG550	550	600	477
MPSREG600	600	650	527

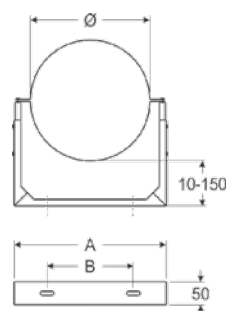

**PROLUNGA PER MPS - MPS EXTENSION - RALLONGE POUR MPS**

Cod. / Code / Réf.	L
PROLMPS105I	105mm
PROLMPS205I	205mm

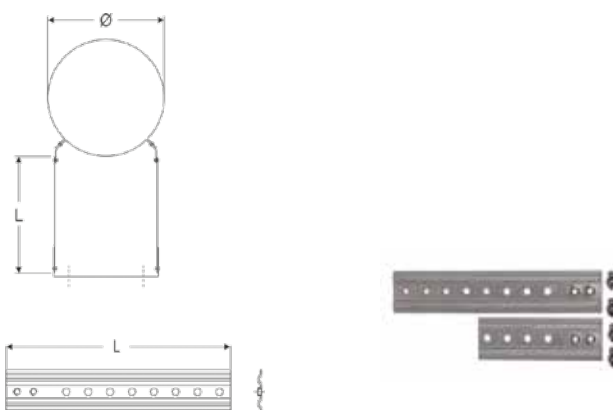

**STAFFA REGOLABILE PER CORNICIONE - ADJUSTABLE ROOF BRACKET - SUPPORT RÉGLABLE POUR CORNICHE**

Cod. / Code / Réf.	Ø
MPSCOR130	130
MPSCOR150	150
MPSCOR170	170
MPSCOR180	180
MPSCOR190	190
MPSCOR200	200
MPSCOR230	230
MPSCOR250	250
MPSCOR300	300
MPSCOR350	350

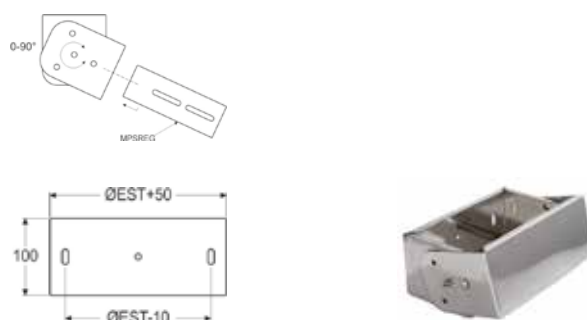

**COLLARE PER CAVITIRANTI - GUY WIRE BRACKET - BRIDE DE HAUBANAGE**

Cod. / Code / Réf.	Ø
MPCOL130	130
MPCOL150	150
MPCOL170	170
MPCOL180	180
MPCOL190	190
MPCOL200	200
MPCOL230	230
MPCOL250	250
MPCOL300	300
MPCOL350	350
MPCOL400	400
MPCOL450	450
MPCOL500	500
MPCOL550	550
MPCOL600	600

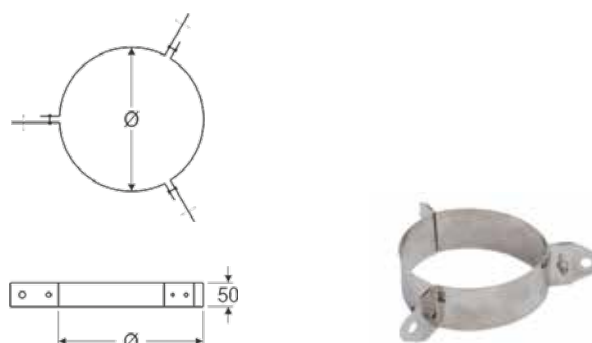

DP INOX +  
DP INOX SP10

## GREMBIULINA DITENUTA - STORM COLLAR - COLLET ANTI-INTEMPÉRIE

Cod. / Code / Réf.	Ø
MPGRE130	130
MPGRE150	150
MPGRE170	170
MPGRE180	180
MPGRE190	190
MPGRE200	200
MPGRE230	230
MPGRE250	250
MPGRE300	300
MPGRE350	350
MPGRE400	400
MPGRE450	450
MPGRE500	500
MPGRE550	550
MPGRE600	600

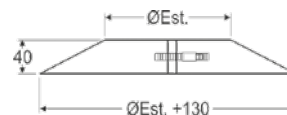

## FALDALE PERTETTI INCLINATI CON BASE IN PIOMBO - FLASHING FOR SLOPED ROOFS WITH LEAD BASE - SOLIN DE TOITS PENTU AVEC BASE EN PLOMB

Cod. / Code / Réf.	Ø	ØF	A	B	H
MPFI130	130	160	500	700	180
MPFI150	150	180	500	700	180
MPFI170	170	210	700	1000	180
MPFI180	180	210	700	1000	180
MPFI190	190	230	700	1000	180
MPFI200	200	230	700	1000	180
MPFI230	230	260	700	1000	180
MPFI250	250	280	700	1000	180
MPFI300	300	330	700	1000	180
MPFI350	350	380	1000	1000	180
MPFI400	400	430	1000	1000	120

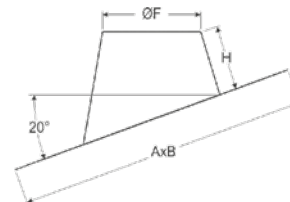

## FALDALE PERTETTI PIANI - FLASHING FOR FLAT ROOFS - SOLIN DE TOITS TERRASSE

Cod. / Code / Réf.	Ø	A	B
MPFP130	130	310	310
MPFP150	150	330	330
MPFP170	170	350	350
MPFP180	180	360	360
MPFP190	190	370	370
MPFP200	200	380	380
MPFP230	230	410	410
MPFP250	250	430	430
MPFP300	300	480	480
MPFP350	350	490	490
MPFP400	400	580	580

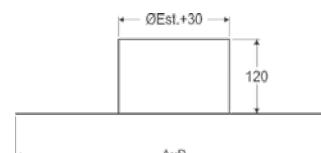

## FASCETTA STRINGITUBO - CLAMP - COLLIER DE JONCTION SIMPLE

Cod. / Code / Réf.	Ø
42MPFASC130	130
42MPFASC150	150
42MPFASC170	170
42MPFASC180	180
42MPFASC190	190
42MPFASC200	200
42MPFASC230	230
42MPFASC250	250
42MPFASC300	300
42MPFASC350	350
42MPFASC400	400
30MPFASC450	450
30MPFASC500	500
30MPFASC550	550
30MPFASC600	600



## GUARNIZIONE - GASKET - JOINT D'ÉTANCHÉITÉ

Cod. / Code / Réf. H12 - 12mm	Cod. / Cod. / Réf. H9 - 9mm.	Ø
G3L80	G3L80H9	80
G3L100	G3L100H9	100
G3L120	G3L120H9	120
G3L130	G3L130H9	130
G3L140	G3L140H9	140
G3L150	G3L150H9	150
G3L180	G3L180H9	180
G3L200	G3L200H9	200
G3L250	G3L250H9	250
G3L300	G3L300H9	300
G3L350	G3L350H9	350
G3L400	G3L400H9	400
G3L450	G3L450H9	450
G3L500	G3L500H9	500



DP INOX +  
 DP INOX SP10



## ELEMENTO LINEARE - STRAIGHT ELEMENT - LONGUEUR DROITE

Articoli imballati singolarmente / One item boxes / Articles emballés séparément

Lunghezza / Length / Longueur: 1000 mm

Cod. / Code / Réf.	Ø Interno / Internal / Intérieur	Ø Esterno / External / Extérieur
10DPG80X1000	*80	100
10DPG100X1000	*100	120
10DPG120X1000	*120	140
10DPG130X1000	*130	150

Lunghezza / Length / Longueur: 500 mm

10DPG80X500	*80	100
10DPG100X500	*100	120
10DPG120X500	*120	140
10DPG130X500	*130	150

Lunghezza / Length / Longueur: 250 mm

10DPG80X250	*80	100
10DPG100X250	*100	120
10DPG120X250	*120	140
10DPG130X250	*130	150

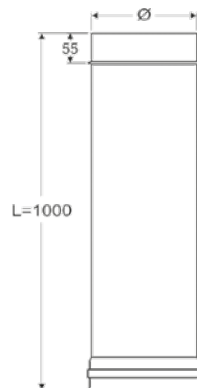

**Diametri differenti su richiesta** - Custom diameters upon request - Diamètres différents sur demande

**\* Guarnizione e fascetta stringitubo incluse** / gasket and clamp included / joint d'étanchéité et collier de jonction compris

## CURVA 90° - 90° ELBOW - COUDE À 90°

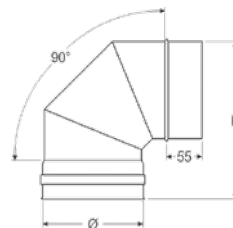
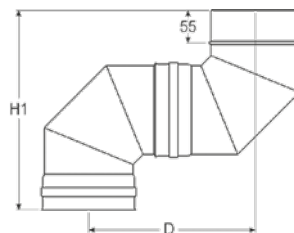

Cod. / Code / Réf.	H	H1	D	N° SET	Ø Int. / Inte. / Intér.	Ø Est. / Exte. / Extér.
10DPGC80/90	228	356	301	3	*80	100
10DPGC100/90	248	376	321	3	*100	120
10DPGC120/90	268	396	341	3	*120	140
10DPGC130/90	278	406	351	3	*130	150



**Diametri differenti su richiesta** - Custom diameters upon request - Diamètres différents sur demande

**CURVA 45° - 45° ELBOW - COUDE À 45°**

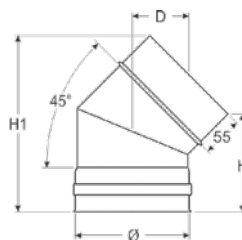
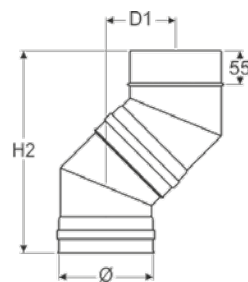

Cod. / Code / Réf.	H	H1	H2	D	D1	N° SET	Ø Int. / Inte. / Intér.	Ø Est. / Exte. / Extér.
10DPGC80/45	128	206	295	69	99	2	*80	100
10DPGC100/45	132	225	319	74	109	2	*100	120
10DPGC120/45	132	238	332	77	115	2	*120	140
10DPGC130/45	151	285	397	90	142	2	*130	150

**Diametri differenti su richiesta** - Custom diameters upon request - Diamètres différents sur demande

**T 90° STACCO MONO - 90° TEE WITH SINGLE WALL CENTRAL FITTING - TÉ À 90° AVEC RACCORD HORIZONTAL SIMPLE PAROI**

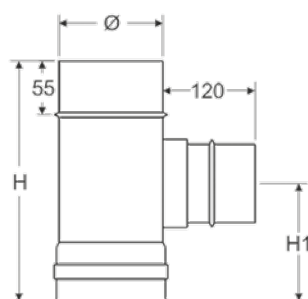

Cod. / Code / Réf.	H	H1	Ø Int. / Inte. / Intér.	Ø Est. / Exte. / Extér.
10DPGT80/90MP	245	120	*80	100
10DPGT100/90MP	255	125	*100	120
10DPGT120/90MP	315	155	*120	140
10DPGT130/90MP	315	155	*130	150

**Diametri differenti su richiesta. Specificare M o F** - Custom diameters upon request. Indicate M or F - Diamètres différents sur demande. Indiquer M ou F

**T 90° STACCO DOPPIA - 90° TEE WITH DOUBLE WALL CENTRAL FITTING - TÉ À 90° AVEC RACCORD HORIZONTAL DOUBLE PAROI**

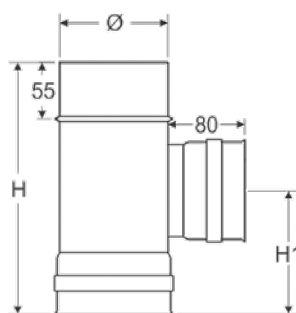

Cod. / Code / Réf.	H	H1	Ø Int. / Inte. / Intér.	Ø Est. / Exte. / Extér.
10DPGT80/90	245	120	*80	100
10DPGT100/90	255	125	*100	120
10DPGT120/90	315	155	*120	140
10DPGT130/90	315	155	*130	150

**Diametri differenti su richiesta** - Custom diameters upon request - Diamètres différents sur demande

**T 90° STACCO RIDOTTO Ø 80 MONO - 90° REDUCING TEE TO Ø 80 SINGLE WALL - TÉ À 90° REDUIT SIMPLE PAROI Ø 80**

Cod. / Code / Réf.	Ø Int. / Inte. /Intér.	Ø Est. / Exte. / Extér.
10DPGTR100-80MP	*100	120
10DPGTR120-80MP	*120	140
10DPGTR130-80MP	*130	150

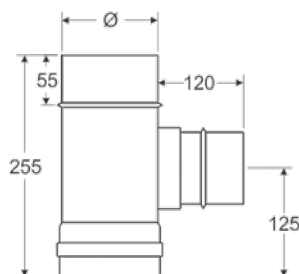

**Diametri differenti su richiesta. Specificare M o F** - Custom diameters upon request. Indicate M or F - Diamètres différents sur demande. Indiquer M ou F

**T 90° STACCO RIDOTTO Ø 80 DOPPIA - 90° REDUCING TEE TO Ø 80 DOUBLE WALL - TÉ À 90° REDUIT DOUBLE PAROI Ø 80**

Cod. / Code / Réf.	Ø Int. / Inte. /Intér.	Ø Est. / Exte. / Extér.
10DPGTR100-80	*100	120
10DPGTR120-80	*120	140
10DPGTR130-80	*130	150

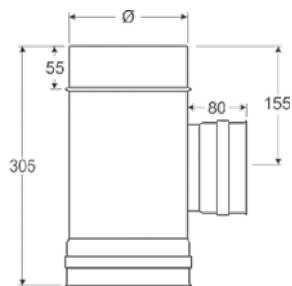

**Diametri differenti su richiesta** - Custom diameters upon request - Diamètres différents sur demande

**MODULO DI ISPEZIONE CONTAPPO TONDO - ELEMENT WITH ROUND INSPECTION DOOR - ÉLÉMENT D'INSPECTION AVEC TRAPPE DE VISITE RONDE**

Cod. / Code / Réf.	H	Øi	Ø Int. / Inte. /Intér.	Ø Est. / Exte. / Extér.
10DPGISP80/90	210	80	*80	100
10DPGISP100/90	245	80	*100	120
10DPGISP120/90	245	80	*120	140
10DPGISP130/90	245	80	*130	150

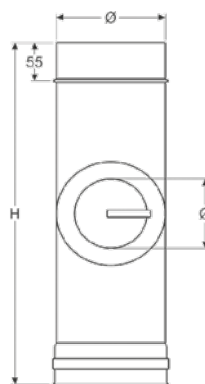

**Diametri differenti su richiesta** - Custom diameters upon request - Diamètres différents sur demande

## SUPPORTO A MURO - WALL SUPPORT - SUPPORT MURAL

Cod. / Code / Réf.	Ø Int. / Inte. /Intér.	Ø Est. / Exté. / Extér.
10DPGSMU80	*80	100
10DPGSMU100	*100	120
10DPGSMU120	*120	140
10DPGSMU130	*130	150

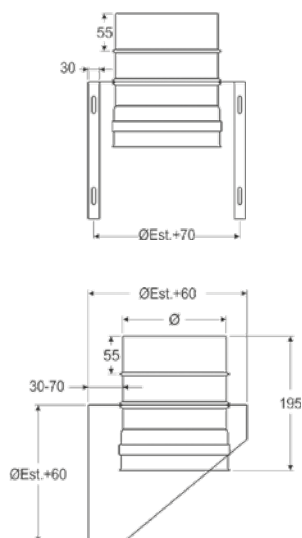

**Diametri differenti su richiesta** - Custom diameters upon request - Diamètres différents sur demande

## ATTRAVERSAMENTO SOLAIO - INTERMEDIATE ANCHOR PLATE - MODULE DE TRAVERSEMENT DE SOL

Cod. / Code / Réf.	Ø Int. / Inte. /Intér.	Ø Est. / Exté. / Extér.
10DPGSOL80	*80	100
10DPGSOL100	*100	120
10DPGSOL120	*120	140
10DPGSOL130	*130	150

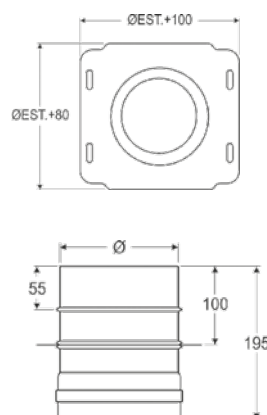

**Diametri differenti su richiesta** - Custom diameters upon request - Diamètres différents sur demande

## RACCORDO MONO-DOPPIA - SINGLE-DOUBLE WALL ADAPTER - RACCORD SIMPLE-DOUBLE PAROI

Cod. Maschio / Male code / Réf. Mâle	Cod. Femmina / Female code / Réf. Femelle	H	Ø Int. / Inte. / Intér.	Ø Est. / Exté. / Extér.
10DPGDM80M	10DPGDM80F	170	*80	100
10DPGDM100M	10DPGDM100F	170	*100	120
10DPGDM120M	10DPGDM120F	170	*120	140
10DPGDM130M	10DPGDM130F	170	*130	150

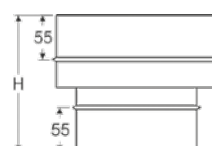
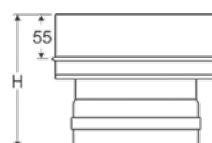

**Diametri differenti su richiesta** - Custom diameters upon request - Diamètres différents sur demande



**RACCORDO DOPPIA-MONO - DOUBLE-SINGLE WALL ADAPTER - RACCORD DOUBLE-SIMPLE PAROI**

Cod. Maschio / Male code / Réf. Mâle	Cod. Femmina / Female code / Réf. Femelle	H	Ø Int. / Inte. / Intér.	Ø Est. / Exte. / Extér.
10DPGMD80M	10DPGMD80F	170	*80	100
10DPGMD100M	10DPGMD100F	170	*100	120
10DPGMD120M	10DPGMD130F	170	*120	140
10DPGMD130M	10DPGMD160F	170	*130	150

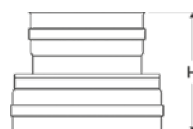

**Diametri differenti su richiesta** - Custom diameters upon request - Diamètres différents sur demande

**RACCOGLI CONDENSA - DRAIN PLUG - BOUCHON DE CONDENSATION**

Cod. / Code / Réf.	Ø Int. / Inte. /Intér.	Ø Est. / Exte. / Extér.
10DPGRC80	*80	100
10DPGRC100	*100	120
10DPGRC120	*120	140
10DPGRC130	*130	150

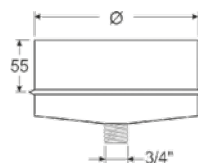

**Diametri differenti su richiesta** - Custom diameters upon request - Diamètres différents sur demande

**COMIGNOLO CINESE - CHINESE CAP - CHAPEAU CHINOIS**

Cod. / Code / Réf.	H	A	He	Ø Int. / Inte. /Intér.	Ø Est. / Exte. / Extér.
10DPGCIN80	205	230	70	80	100
10DPGCIN100	205	265	70	100	120
10DPGCIN120	210	265	75	120	140
10DPGCIN130	225	320	90	130	150

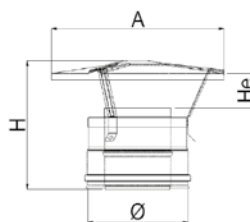

**Diametri differenti su richiesta** - Custom diameters upon request - Diamètres différents sur demande  
**Fascetta non inclusa** - Clamp not included - Collier de jonction pas compris

## COMIGNOLO ANTIVENTO - WINDPROOF CAP - CHAPEAU ANTI-INTEMPÉRIE

Cod. / Code / Réf.	H	A	hF	Ø Int. / Inte. / Intér.	Ø Est. / Exte. / Extér.
10DPGAV80	240	185	165	80	100
10DPGAV100	240	220	165	100	120
10DPGAV120	260	260	200	120	140
10DPGAV130	280	300	200	130	150

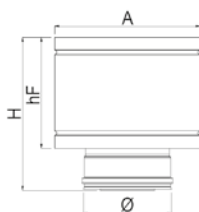

**Diametri differenti su richiesta** - Custom diameters upon request - Diamètres différents sur demande  
**Fascetta non inclusa** - Clamp not included - Collier de jonction pas compris

## COMIGNOLO TORRINO - TOWER CAP - CHAPEAU DONJON

Cod. / Code / Réf.	H	A	hL	N° CONI	Ø Int. / Inte. / Intér.	Ø Est. / Exte. / Extér.
10DPGTOR80	180	130	20	3	80	100
10DPGTOR100	215	150	20	4	100	120
10DPGTOR120	220	180	22	4	120	140
10DPGTOR130	220	180	22	4	130	150

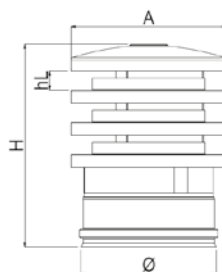

**Diametri differenti su richiesta** - Custom diameters upon request - Diamètres différents sur demande  
**Fascetta non inclusa** - Clamp not included - Collier de jonction pas compris

## COMIGNOLO TRONCO/CONICO - CONE TERMINAL - CÔNE DE FINITION

Cod. / Code / Réf.	Ø Int. / Inte. / Intér.	Ø Est. / Exte. / Extér.
10DPGTC80	80	100
10DPGTC100	100	120
10DPGTC120	120	140
10DPGTC130	130	150

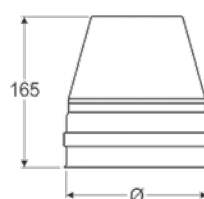

**Diametri differenti su richiesta** - Custom diameters upon request - Diamètres différents sur demande  
**Fascetta non inclusa** - Clamp not included - Collier de jonction pas compris

**TERMINALE ORIZZONTALE DOPPIA PARETE - DOUBLE WALL HORIZONTAL ENDING PART - TERMINAL HORIZONTAL À BEC DOUBLE PAROI**

Cod. / Code / Réf.	L	Ø Int. / Inte. /Intér.	Ø Est. / Exte. / Extér.
10DPGT080	187	80	100
10DPGT0100	202	100	120
10DPGT0120	220	120	140
10DPGT0130	225	130	150

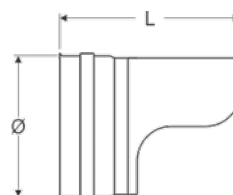

**Diametri differenti su richiesta** - Custom diameters upon request - Diamètres différents sur demande  
**Fascetta non inclusa** - Clamp not included - Collier de jonction pas compris

**STAFFA DI FISSAGGIO A PARETE REGOLABILE DA 50 A 80 mm - ADJUSTABLE WALL BRACKET FROM 50 TO 80 mm - COLLIER DE FIXATION MURAL RÉGLABLE DE 50 À 80 mm**

Cod. / Code / Réf.	Ø	A	B	D
MPS100	100	114	67	50-80
MPS120	120	128	68	50-80
MPS140	140	145	85	50-80
MPS150	150	148	86	50-80

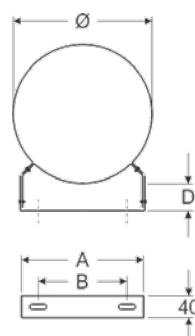

**STAFFA DI FISSAGGIO A PARETE REGOLABILE DA 10 A 150 mm - ADJUSTABLE WALL BRACKET FROM 10 TO 150 mm - COLLIER DE FIXATION MURAL RÉGLABLE DE 10 À 150 mm**

Cod. / Code / Réf.	Ø	A	B
MPSREG100	100	149	94
MPSREG120	120	163	103
MPSREG150	150	200	134
MPSREG180	180	230	170

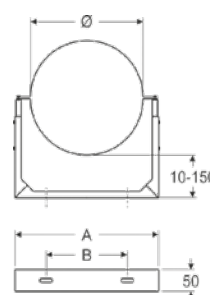

**PROLUNGA PER MPS - MPS EXTENSION - RALLONGE POUR MPS**

Cod. / Code / Réf.	L
PROLMPS105I	105mm
PROLMPS205I	205mm

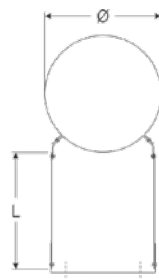

**FALDALE PER TETTI INCLINATI CON BASE IN PIOMBO - FLASHING FOR SLOPED ROOFS WITH LEAD BASE - SOLIN DE TOIT PENTU AVEC BASE EN PLOMB**

Cod. / Code / Réf.	Ø	ØF	A	B	H
MPFI100	100	130	500	700	180
MPFI120	120	160	500	700	180
MPFI140	150	180	500	700	180
MPFI150	180	180	500	700	180

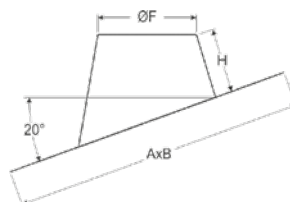

**FALDALE PER TETTI PIANI - FLASHING FOR FLAT ROOFS - SOLIN TOITS TERRASSE**

Cod. / Code / Réf.	Ø	A	B
MPFP100	100	300	300
MPFP120	120	310	310
MPFP140	140	330	330
MPFP150	150	330	330

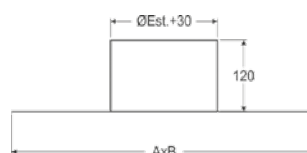

DP INOX +  
DP INOX SP10

# GREMBIULINA DITENUTA - STORM COLLAR - COLLET ANTI-INTEMPÉRIE

Cod. / Code / Réf.	Ø
MPGRE100	100
MPGRE120	120
MPGRE140	140
MPGRE150	150

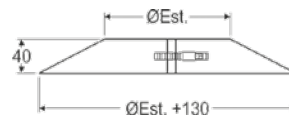



DP INOX +  
DP INOX SP10