

DP rame + DP rame SP10

La serie "RDPG", "50RDPG" e "10RDPG" è composta da due tubi. La parete interna è in acciaio inox AISI 316 L (DIN 1.4404) mentre la parete esterna è in rame. L'isolamento è composto da lana di roccia ad alta densità di spessore 25 mm per la serie RDPG dal Ø80 fino al Ø350 interno, di spessore 50 mm per la serie 50RDPG dal Ø350 fino al Ø500 interno e di spessore 10 mm per la serie 10RDPG dal Ø80 fino al Ø130 interno. La guarnizione, di tipo siliconica nera a triplo labbro, è fornita di serie dal Ø80 fino al Ø150 interno. Il sistema di giunzione è di tipo maschio/femmina, mentre il sistema di saldatura è longitudinale continuo al TIG o PLASMA. Per la serie RDPG e 50RDPG, il sistema camino è idoneo per l'evacuazione dei fumi condensati o secchi per funzionamento in pressione negativa (N1) o positiva (P1). La temperatura max di esercizio per funzionamento in N1 è di 600° C senza guarnizione, mentre per funzionamento in P1 è di 200° C con guarnizione. Sono ammessi combustibili solidi per funzionamento a secco, liquidi e gassosi per funzionamento a umido e secco. Per la serie 10RDPG, il canale da fumo e condotto fumario è idoneo per l'evacuazione dei fumi condensati o secchi per funzionamento in pressione positiva (P1). La temperatura max di esercizio per funzionamento in P1 è di 200° C con guarnizione. Sono ammessi combustibili liquidi e gassosi per funzionamento a umido e pellet.

The "RDPG", "50RDPG" and "10RDPG" series are composed of two pipes. The inner wall is made of AISI 316L stainless steel (DIN 1.4404) while the outer wall is made of copper. The insulation for the RDPG series is made of high density 25mm thick rock wool from Ø80 up to Ø350 inside, while it is 50mm thick for the 50RDPG series from Ø350 up to Ø500 inside and it is 10mm thick for the 10RDPG series from Ø80 up to Ø130 inside. The black silicone gasket is supplied as standard from Ø80 up to Ø150 inside. The joint system is of male / female type, while the welding system is longitudinal continuous to TIG or PLASMA. Concerning the RDPG and 50RDPG series, the chimney system is suitable for the evacuation of condensed or dried smokes for operations under negative N1 or positive P1 pressure. The maximum operating temperature for N1 operations is 600°C without gasket, while it is 200°C for P1 operations with gasket. Solid fuels are allowed for dry running, while liquid and gaseous fuels for operations in wet and dry runnings. As for 10RDPG series, the connecting flue pipe, such as the flue liner, are suitable for the evacuation of condensed or dried smokes for operations in positive pressure (P1). The maximum operating temperature is 200°C for P1 operation with gasket. Liquid and gaseous fuels are allowed for wet running and pellets.

La série "RDPG", "50RDPG" et "10RDPG" est composée de deux tubes. La paroi Intérieure est en acier inoxydable AISI 316L (DIN 1.4404) tandis que la paroi Extérieure est en cuivre. L'isolation est en laine de roche haute densité épaisseur 25mm pour la série RDPG du Ø80 au Ø350 Intérieur, alors qu'il est de 50mm d'épaisseur pour la série 50RDPG du Ø350 au Ø500 Intérieur et enfin il est de 10mm d'épaisseur pour la série 10RDPG du Ø80 au Ø130 Intérieur. Le joint en silicone noir est fourni de série du Ø80 jusqu'au Ø150 Intérieur. Le système de jonction est de type mâle / femelle et le système de soudage est longitudinal en continu au TIG ou au PLASMA. Pour les séries RDPG et 50RDPG, le canal de fumée et même le conduit sont adaptés pour l'évacuation des condensats ou des fumées sèches aussi bien en pression positive que négative. La température maximale de fonctionnement en N1 est de 200°C avec joint tandis qu'elle est de 600°C pour le fonctionnement en N1 sans joint. Les combustibles gazeux et liquides sont admis pour un fonctionnement à sec ou humide, par contre les combustibles solides nécessitent d'un fonctionnement à sec. Pour la série 10RDPG, le canal de fumée et même le conduit sont adaptés pour l'évacuation des condensats ou des fumées sèches sous une pression positive (P1). La température maximale de fonctionnement en P1 est de 200°C avec joint. Les combustibles gazeux et liquides sont admis pour un fonctionnement humide et pour les pellets.

ELEMENTO LINEARE - STRAIGHT ELEMENT - LONGUEUR DROITE
FASCETTA STRINGITUBO INCLUSA / CLAMP INCLUDED / COLLIER DE JONCTION COMPRIS

Lunghezza / Length / Longueur: 1000 mm

Cod. / Code / Réf.	Ø Interno / Internal / Intérieur	Ø Esterno / External / Extérieur
RDPG80X1000	*80	130
RDPG100X1000	*100	150
RDPG120X1000	*120	170
RDPG130X1000	*130	180
RDPG140X1000	*140	190
RDPG150X1000	*150	200
RDPG180X1000	180	230
RDPG200X1000	200	250
RDPG250X1000	250	300
RDPG300X1000	300	350
RDPG350X1000	350	400
50RDPG350X1000	350	450
50RDPG400X1000	400	500
50RDPG450X1000	450	550
50RDPG500X1000	500	600

Lunghezza / Length / Longueur: 500 mm

RDPG80X500	*80	130
RDPG100X500	*100	150
RDPG120X500	*120	170
RDPG130X500	*130	180
RDPG140X500	*140	190
RDPG150X500	*150	200
RDPG180X500	180	230
RDPG200X500	200	250
RDPG250X500	250	300
RDPG300X500	300	350
RDPG350X500	350	400
50RDPG350X500	350	450
50RDPG400X500	400	500
50RDPG450X500	450	550
50RDPG500X500	500	600

Lunghezza / Length / Longueur: 250 mm

RDPG80X250	*80	130
RDPG100X250	*100	150
RDPG120X250	*120	170
RDPG130X250	*130	180
RDPG140X250	*140	190
RDPG150X250	*150	200
RDPG180X250	180	230
RDPG200X250	200	250
RDPG250X250	250	300
RDPG300X250	300	350
RDPG350X250	350	400
50RDPG350X250	350	450
50RDPG400X250	400	500
50RDPG450X250	450	550
50RDPG500X250	500	600

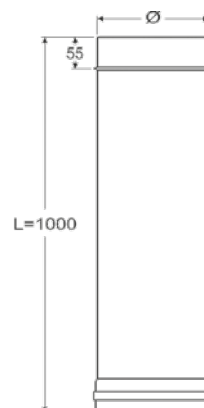

* **Guarnizione inclusa** / Gasket included / Joint d'étanchéité compris
 ** **Quotazioni su richiesta** / Quotations upon request / Devis sur demande

ELEMENTO TELESCOPICO (mm 480X740) - ADJUSTABLE PIPE - LONGUEUR DROITE AJUSTABLE

Cod. / Code / Réf.	Ø Interno / Internal / Intérieur	Ø Esterno / External / Extérieur
RDPGTEL80	*80	130
RDPGTEL100	*100	150
RDPGTEL120	*120	170
RDPGTEL130	*130	180
RDPGTEL140	*140	190
RDPGTEL150	*150	200
RDPGTEL180	180	230
RDPGTEL200	200	250
RDPGTEL250	250	300
RDPGTEL300	300	350
RDPGTEL350	350	400
50RDPGTEL350	350	450
50RDPGTEL400	400	500
50RDPGTEL450	450	550
50RDPGTEL500	500	600

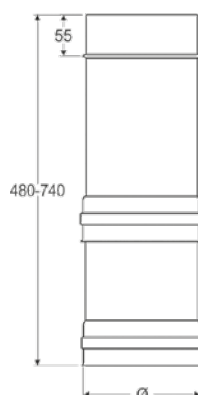

Diametri maggiori su richiesta - Bigger diameters upon request - Diamètres plus grand sur demande

CURVA 30° - 30° ELBOW - COUDE À 30°

Cod. / Code / Réf.	H	H1	H2	D	D1	N° SET	Ø Int. / Inte. / Intér.	Ø Est. / Exte. / Extér.
RDPGC80/30	143	208	303	47	66	2	*80	130
RDPGC100/30	142	217	311	48	69	2	*100	150
RDPGC120/30	152	237	324	52	76	2	*120	170
RDPGC130/30	141	231	324	50	72	2	*130	180
RDPGC140/30	143	238	333	51	74	2	*140	190
RDPGC150/30	162	262	377	57	86	2	*150	200
RDPGC180/30	136	251	340	53	76	2	180	230
RDPGC200/30	150	275	378	57	86	2	200	250
RDPGC250/30	139	289	380	57	87	2	250	300
RDPGC300/30	144	319	415	62	96	2	300	350
RDPGC350/30	142	342	436	65	102	2	350	400
50RDPGC350/30							350	450
50RDPGC400/30							400	500
50RDPGC450/30							450	550
50RDPGC500/30							500	600

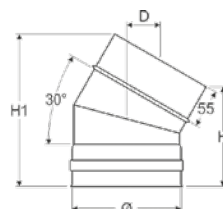
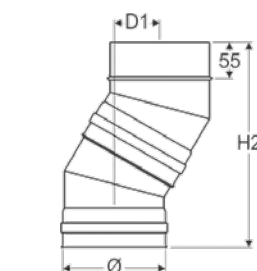

DP FRAME +
DP FRAME SP10

CURVA 45° - 45° ELBOW - COUDE À 45°

Cod. / Code / Réf.	H	H1	H2	D	D1	N° SET	Ø Int. / Inte. / Intér.	Ø Est. / Exte. / Extér.
RDPGC80/45	149	241	350	79	122	3	*80	130
RDPGC100/45	151	257	367	82	129	3	*100	150
RDPGC120/45	168	288	415	92	149	3	*120	170
RDPGC130/45	140	268	367	82	129	3	*130	180
RDPGC140/45	164	288	422	94	152	3	*140	190
RDPGC150/45	151	292	404	92	145	3	*150	200
RDPGC180/45	172	335	467	103	171	3	180	230
RDPGC200/45	196	373	528	116	196	3	200	250
RDPGC250/45	182	394	536	117	199	3	250	300
RDPGC300/45	165	412	536	117	199	3	300	350
RDPGC350/45	165	448	574	127	215	3	350	400
50RDPGC350/45							350	450
50RDPGC400/45							400	500
50RDPGC450/45							450	550
50RDPGC500/45							500	600

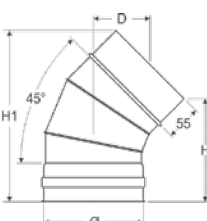
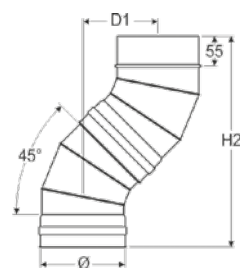

CURVA 90° - 90° ELBOW - COUDE À 90°

Cod. / Code / Réf.	H	H1	D	N° SET	Ø Int. / Inte. /Intér.	Ø Est. / Exte. / Extér.
RDPGC80/90	250	370	315	4	*80	130
RDPGC100/90	265	375	320	4	*100	150
RDPGC120/90	300	424	369	4	*120	170
RDPGC130/90	324	462	407	4	*130	180
RDPGC140/90	334	472	417	4	*140	190
RDPGC150/90	342	480	425	4	*150	200
RDPGC180/90	372	509	454	4	180	230
RDPGC200/90	406	558	503	4	200	250
RDPGC250/90	466	626	571	4	250	300
RDPGC300/90	524	693	638	4	300	350
RDPGC350/90	545	689	634	4	350	400
50RDPGC350/90					350	450
50RDPGC400/90					400	500
50RDPGC450/90					450	550
50RDPGC500/90					500	600

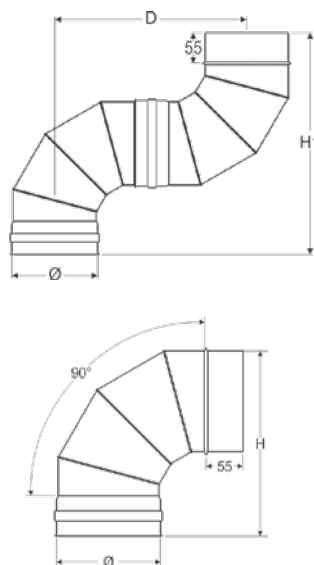

T 90° CON ISPEZIONE - 90° TEE WITH INSPECTION DOOR - TÉ À 90° AVEC TRAPPE DE VISITE

Cod. / Code / Réf.	H	H1	Øi	Ø Int. / Inte. /Intér.	Ø Est. / Exte. / Extér.
RDPGT80/90ISP	310	155	80	*80	130
RDPGT100/90ISP	320	160	80	*100	150
RDPGT120/90ISP	400	200	80	*120	170
RDPGT130/90ISP	500	250	80	*130	180
RDPGT140/90ISP	500	250	100	*140	190
RDPGT150/90ISP	500	250	100	*150	200
RDPGT180/90ISP	500	250	150	180	230
RDPGT200/90ISP	500	250	150	200	250
RDPGT250/90ISP	500	250	150	250	300

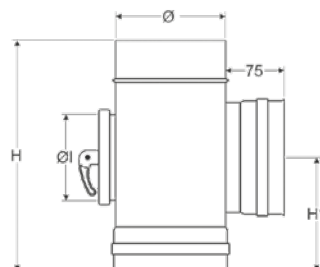

T 90° - 90° TEE - TÉ À 90°

Cod. / Code / Réf.	H	H1	Ø Int. / Inte. /Intér.	Ø Est. / Exte. / Extér.
RDPGT80/90	310	155	*80	130
RDPGT100/90	320	160	*100	150
RDPGT120/90	400	200	*120	170
RDPGT130/90	500	250	*130	180
RDPGT140/90	500	250	*140	190
RDPGT150/90	500	250	*150	200
RDPGT180/90	500	250	180	230
RDPGT200/90	500	250	200	250
RDPGT250/90	500	250	250	300
RDPGT300/90	500	250	300	350
RDPGT350/90	600	300	350	400
50RDPGT350/90				450
50RDPGT400/90				500
50RDPGT450/90				550
50RDPGT500/90				600

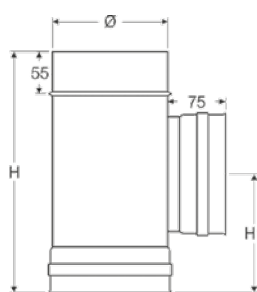

T 90° CON ATTACCO LATERALE RIDOTTO A Ø80-130 (DOPPIA PARETE) - 90° REDUCING TEE TO Ø 80-130 (DOUBLE WALL) - TÉ À 90° REDUIT Ø 80-130 (DOUBLE PAROI)

Cod. / Code / Réf.	Ø Interno / Internal / Intérieur	Ø Esterno / External / Extérieur
RDPGTR100-80	*100	150
RDPGTR120-80	*120	170
RDPGTR130-80	*130	180
RDPGTR140-80	*140	190
RDPGTR150-80	*150	200
RDPGTR180-80	180	230
RDPGTR200-80	200	250
RDPGTR250-80	250	300
RDPGTR300-80	300	350

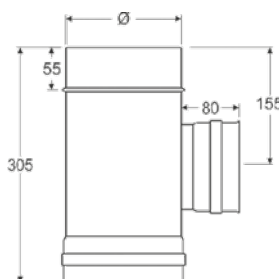

T 90° CON ATTACCO LATERALE RIDOTTO A Ø80 (MONO PARETE) - 90° REDUCING TEE TO Ø 80 (SINGLE WALL) - TÉ À 90° REDUIT Ø 80 (SIMPLE PAROI)

Cod. / Code / Réf.	Ø Interno / Internal / Intérieur	Ø Esterno / External / Extérieur
RDPGTR100-80MP	*100	150
RDPGTR120-80MP	*120	170
RDPGTR130-80MP	*130	180
RDPGTR140-80MP	*140	190
RDPGTR150-80MP	*150	200
RDPGTR180-80MP	180	230
RDPGTR200-80MP	200	250
RDPGTR250-80MP	250	300
RDPGTR300-80MP	300	350

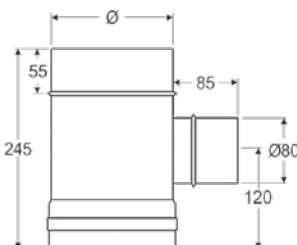

Diametri maggiori su richiesta. Specificare M o F - Bigger diameters upon request. Indicate M or F - Diamètres plus grands sur demande. Indiquer si M ou F.

T 135° - 135° TEE - TÉ À 135°

Cod. / Code / Réf.	H	H1	D	DO	HO	DV	HV	Ø Int. / Inte. / Intér.	Ø Est. / Exte. / Extér.
RDPGT80/135	435	120	209	384	432	260	491	*80	130
RDPGT100/135	463	127	226	396	462	276	508	*100	150
RDPGT120/135	491	134	243	425	496	296	541	*120	170
RDPGT130/135	506	138	252	419	508	300	536	*130	180
RDPGT140/135	520	141	260	455	532	318	574	*140	190
RDPGT150/135	534	145	269	451	544	323	572	*150	200
RDPGT180/135	615	168	301	506	623	362	653	180	230
RDPGT200/135	645	175	318	563	672	395	715	200	250
RDPGT250/135	715	193	361	608	753	440	770	250	300
RDPGT300/135	786	210	403	648	829	482	820	300	350
RDPGT350/135	750	159	416	745	904	529	920	350	400
50RDPGT350/135								350	450
50RDPGT400/135								400	500
50RDPGT450/135								450	550
50RDPGT500/135								500	600

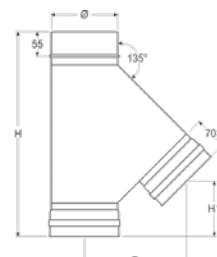
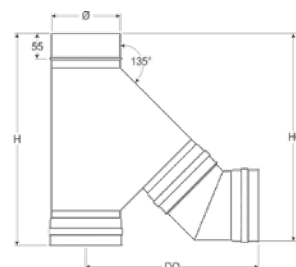
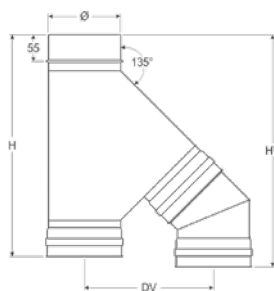

RACCORDO MONO/DOPPIA - SINGLE/DOUBLE WALL ADAPTER - RACCORD SIMPLE/DOUBLE PAROI

Cod. Maschio / Male code / Réf. Mâle	Cod. Femmina / Female code / Réf. Femelle	H	Ø Int. / Inte. / Intér.	Ø Est. / Exte. / Extér.
DPGDM80M	DPGDM80F	170	*80	130
DPGDM100M	DPGDM100F	170	*100	150
DPGDM120M	DPGDM120F	170	*120	170
DPGDM130M	DPGDM130F	170	*130	180
DPGDM140M	DPGDM140F	170	*140	190
DPGDM150M	DPGDM150F	170	*150	200
DPGDM180M	DPGDM180F	170	180	230
DPGDM200M	DPGDM200F	170	200	250
DPGDM250M	DPGDM250F	170	250	300
DPGDM300M	DPGDM300F	170	300	350
DPGDM350M	DPGDM350F	170	350	400
50DPGDM350M	50DPGDM350F	250	350	450
50DPGDM400M	50DPGDM400F	250	400	500
50DPGDM450M	50DPGDM450F	250	450	550
50DPGDM500M	50DPGDM500F	250	500	600

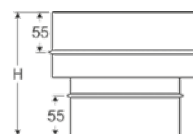
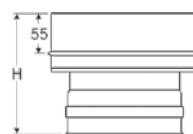

RACCORDO DOPPIA/MONO - DOUBLE/SINGLE WALL ADAPTER - RACCORD DOUBLE/SIMPLE PAROI

Cod. Maschio / Male code / Réf. Mâle	Cod. Femmina / Female code / Réf. Femelle	H	Ø Int. / Inte. / Intér.	Ø Est. / Exte. / Extér.
DPGMD80M	DPGMD80F	170	*80	130
DPGMD100M	DPGMD100F	170	*100	150
DPGMD120M	DPGMD120F	170	*120	170
DPGMD130M	DPGMD130F	170	*130	180
DPGMD140M	DPGMD140F	170	*140	190
DPGMD150M	DPGMD150F	170	*150	200
DPGMD180M	DPGMD180F	170	180	230
DPGMD200M	DPGMD200F	170	200	250
DPGMD250M	DPGMD250F	170	250	300
DPGMD300M	DPGMD300F	170	300	350
DPGMD350M	DPGMD350F	170	350	400
50DPGMD350M	50DPGMD350F	250	350	450
50DPGMD400M	50DPGMD400F	250	400	500
50DPGMD450M	50DPGMD450F	250	450	550
50DPGMD500M	50DPGMD500F	250	500	600

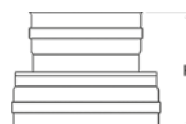
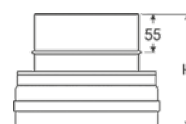

MODULO DI ISPEZIONE CON TAPPO TONDO - ELEMENT WITH ROUND INSPECTION DOOR - ÉLÉMENT AVEC TRAPPE DE VISITE RONDE

Cod. / Code / Réf.	H	Øi	Ø Int. / Inte. /Intér.	Ø Est. / Exte. / Extér.
RDPGISP80/90	250	80	*80	130
RDPGISP100/90	250	80	*100	150
RDPGISP120/90	310	120	*120	170
RDPGISP130/90	310	130	*130	180
RDPGISP140/90	320	140	*140	190
RDPGISP150/90	320	150	*150	200
RDPGISP180/90	500	180	180	230
RDPGISP200/90	500	200	200	250
RDPGISP250/90	500	200	250	300
RDPGISP300/90	500	250	300	350
RDPGISP350/90	500	250	350	400
50RDPGISP350/90	500	250	350	450
50RDPGISP400/90	500	250	400	500
50RDPGISP450/90	500	250	450	550
50RDPGISP500/90	500	250	500	600

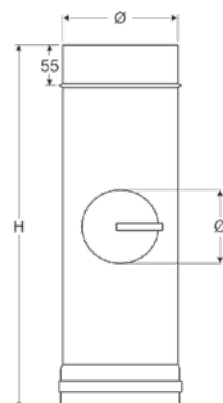

MODULO DI ISPEZIONE CON TAPPO TONDO PER ALTE TEMPERATURE - ELEMENT WITH ROUND INSPECTION DOOR FOR HIGH TEMPERATURES - ÉLÉMENT AVEC TRAPPE DE VISITE RONDE POUR TEMPÉRATURES ÉLEVÉES

Cod. / Code / Réf.	H	Øi	Ø Int. / Inte. /Intér.	Ø Est. / Exte. / Extér.
RDPGISP80/90HT	250	80	*80	130
RDPGISP100/90HT	250	80	*100	150
RDPGISP120/90HT	310	120	*120	170
RDPGISP130/90HT	310	130	*130	180
RDPGISP140/90HT	320	140	*140	190
RDPGISP150/90HT	320	150	*150	200
RDPGISP180/90HT	500	180	180	230
RDPGISP200/90HT	500	200	200	250
RDPGISP250/90HT	500	200	250	300
RDPGISP300/90HT	500	250	300	350
RDPGISP350/90HT	500	250	350	400
50RDPGISP350/90HT	500	250	350	450
50RDPGISP400/90HT	500	250	400	500
50RDPGISP450/90HT	500	250	450	550
50RDPGISP500/90HT	500	250	500	600

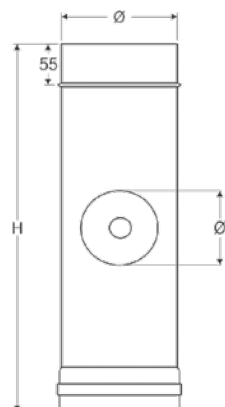

MODULO PRELIEVO FUMI E TEMPERATURA - ELEMENT FOR SMOKES AND TEMPERATURE CHECK - PRÉLÈVEMENT FUMÉE ET TEMPÉRATURE

Cod. / Code / Réf.	Ø Interno / Internal / Intérieur	Ø Esterno / External / Extérieur
RDPGPFT80	*80	130
RDPGPFT100	*100	150
RDPGPFT120	*120	170
RDPGPFT130	*130	180
RDPGPFT140	*140	190
RDPGPFT150	*150	200
RDPGPFT180	180	230
RDPGPFT200	200	250
RDPGPFT250	250	300
RDPGPFT300	300	350
RDPGPFT350	350	400
50RDPGPFT350	350	450
50RDPGPFT400	400	500
50RDPGPFT450	450	550
50RDPGPFT500	500	600

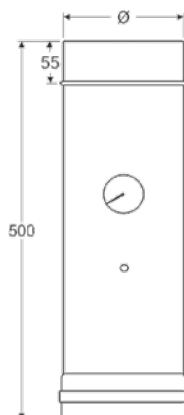

DP RAME +
DP RAME SP10

SUPPORTO A MURO - WALL SUPPORT - SUPPORT MURAL

Cod. / Code / Réf.	Ø Interno / Internal / Intérieur	Ø Esterno / External / Extérieur
RDPGSMU80	*80	130
RDPGSMU100	*100	150
RDPGSMU120	*120	170
RDPGSMU130	*130	180
RDPGSMU140	*140	190
RDPGSMU150	*150	200
RDPGSMU180	180	230
RDPGSMU200	200	250
RDPGSMU250	250	300
RDPGSMU300	300	350
RDPGSMU350	350	400
50RDPGSMU350	350	450
50RDPGSMU400	400	500
50RDPGSMU450	450	550
50RDPGSMU500	500	600

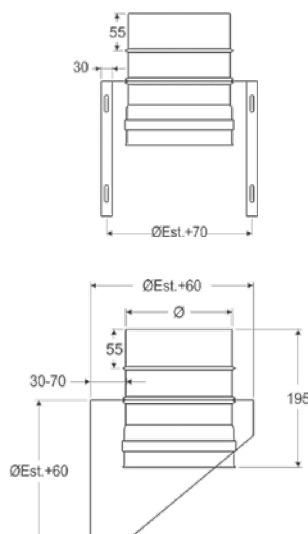

ATTRAVERSAMENTO SOLAIO - INTERMEDIATE ANCHOR PLATE - MODULE DE TRAVERSEMENT DE SOL

Cod. / Code / Réf.	Ø Interno / Internal / Intérieur	Ø Esterno / External / Extérieur
RDPGSOL80	*80	130
RDPGSOL100	*100	150
RDPGSOL120	*120	170
RDPGSOL130	*130	180
RDPGSOL140	*140	190
RDPGSOL150	*150	200
RDPGSOL180	180	230
RDPGSOL200	200	250
RDPGSOL250	250	300
RDPGSOL300	300	350
RDPGSOL350	350	400
50RDPGSOL350	350	450
50RDPGSOL400	400	500
50RDPGSOL450	450	550
50RDPGSOL500	500	600

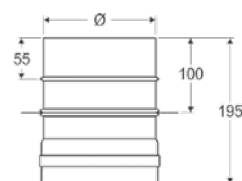
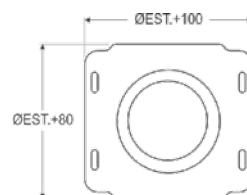

RACCOGLI CONDENSA - DRAIN PLUG - BOUCHON DE CONDENSATION

Cod. / Code / Réf.	Ø Int. / Inte. / Intér.	Ø Est. / Exte. / Extér.
RDPGRC80	*80	130
RDPGRC100	*100	150
RDPGRC120	*120	170
RDPGRC130	*130	180
RDPGRC140	*140	190
RDPGRC150	*150	200
RDPGRC180	180	230
RDPGRC200	200	250
RDPGRC250	250	300
RDPGRC300	300	350
RDPGRC350	350	400
50RDPGRC350	350	450
50RDPGRC400	400	500
50RDPGRC450	450	550
50RDPGRC500	500	600

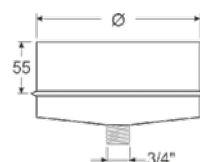

TAPPO CON MANIGLIA - DRAIN PLUG WITH HANDLE - BOUCHON DE CONDENSATION ÉTANCHE

Cod. / Code / Réf.	Ø Int. / Inte. / Intér.	Ø Est. / Exte. / Extér.
RDPGMAN80	*80	130
RDPGMAN100	*100	150
RDPGMAN120	*120	170
RDPGMAN130	*130	180
RDPGMAN140	*140	190
RDPGMAN150	*150	200
RDPGMAN180	180	230
RDPGMAN200	200	250
RDPGMAN250	250	300
RDPGMAN300	300	350
RDPGMAN350	350	400
50RDPGMAN350	350	450
50RDPGMAN400	400	500
50RDPGMAN450	450	550
50RDPGMAN500	500	600

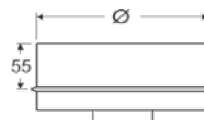

BASE DI PARTENZA CON SCARICO LATERALE - BASE PLATE WITH LATERAL DRAIN - PLAQUE DE DÉPART AVEC ÉVACUATION LATÉRALE

Cod. / Code / Réf.	H	Ø Int. / Inte. /Intér.	Ø Est. / Exte. / Extér.
RDPGRCL80	170	*80	130
RDPGRCL100	170	*100	150
RDPGRCL120	170	*120	170
RDPGRCL130	170	*130	180
RDPGRCL140	170	*140	190
RDPGRCL150	170	*150	200
RDPGRCL180	170	180	230
RDPGRCL200	170	200	250
RDPGRCL250	170	250	300
RDPGRCL300	170	300	350
RDPGRCL350	240	350	400
50RDPGRCL350	240	350	450
50RDPGRCL400	240	400	500
50RDPGRCL450	240	450	550
50RDPGRCL500	240	500	600

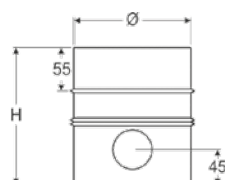
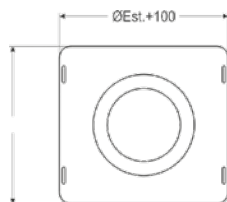

COMIGNOLO CINESE - CHINESE CAP - CHAPEAU CHINOIS

Cod. / Code / Réf.	H	A	He	Ø Int. / Inte. /Intér.	Ø Est. / Exte. / Extér.
RDPGCIN80	195	265	70	80	130
RDPGCIN100	200	265	75	100	150
RDPGCIN120	215	320	90	120	170
RDPGCIN130	215	320	90	130	180
RDPGCIN140	225	320	100	140	190
RDPGCIN150	225	320	100	150	200
RDPGCIN180	250	400	110	180	230
RDPGCIN200	250	400	125	200	250
RDPGCIN250	275	500	150	250	300
RDPGCIN300	300	600	175	300	350
RDPGCIN350	320	600	200	350	400
50RDPGCIN350	220	530	100	350	450
50RDPGCIN400	220	580	100	400	500
50RDPGCIN450	220	630	100	450	550
50RDPGCIN500	220	680	100	500	600

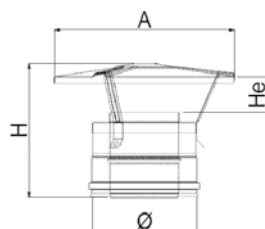

Fascetta non inclusa - Clamp not included - Collier de jonction pas compris

COMIGNOLO ANTIVENTO - WINDPROOF CAP - CHAPEAU ANTI-INTEMPÉRIE

Cod. / Code / Réf.	H	A	hF	Ø Int. / Inte. /Intér.	Ø Est. / Exte. / Extér.
RDPGAV80	240	220	165	80	130
RDPGAV100	260	260	200	100	150
RDPGAV120	280	300	200	120	170
RDPGAV130	280	300	200	130	180
RDPGAV140	320	310	250	140	190
RDPGAV150	320	310	250	150	200
RDPGAV180	340	370	250	180	230
RDPGAV200	340	420	250	200	250
RDPGAV250	400	470	310	250	300
RDPGAV300	400	530	310	300	350
RDPGAV350	500	610	415	350	400
50RDPGAV350	330	650	250	350	450
50RDPGAV400	330	700	250	400	500
50RDPGAV450	330	750	250	450	550
50RDPGAV500	330	800	250	500	600

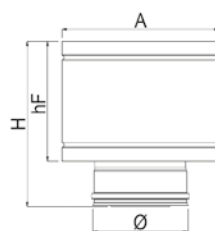

Fascetta non inclusa - Clamp not included - Collier de jonction pas compris

DP RAME +
DP RAME SP10

COMIGNOLO TORRINO - TOWER CAP - CHAPEAU DONJON

Cod. / Code / Réf.	H	N° CONI	Ø Int. / Inte. /Intér.	Ø Est. / Exte. / Extér.
RDPGTOR80	330	3	80	130
RDPGTOR100	330	3	100	150
RDPGTOR120	330	3	120	170
RDPGTOR130	330	3	130	180
RDPGTOR140	330	3	140	190
RDPGTOR150	330	3	150	200
RDPGTOR180	390	4	180	230
RDPGTOR200	390	4	200	250
RDPGTOR250	390	4	250	300
RDPGTOR300	390	5	300	350
RDPGTOR350	390	5	350	400

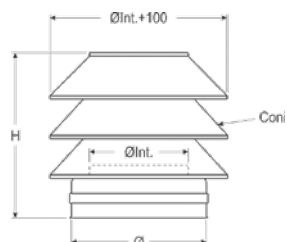

Fascetta non inclusa - Clamp not included - Collier de jonction pas compris

COMIGNOLO TRONCO/CONICO - CONE TERMINAL - CÔNE DE FINITION

Cod. / Code / Réf.	Ø Interno / Internal / Intérieur	Ø Esterno / External / Extérieur
RDPGTC80	80	130
RDPGTC100	100	150
RDPGTC120	120	170
RDPGTC130	130	180
RDPGTC140	140	190
RDPGTC150	150	200
RDPGTC180	180	230
RDPGTC200	200	250
RDPGTC250	250	300
RDPGTC300	300	350
RDPGTC350	350	400
50RDPGTC350	350	450
50RDPGTC400	400	500
50RDPGTC450	450	550
50RDPGTC500	500	600

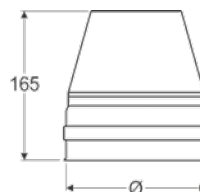

Fascetta non inclusa - Clamp not included - Collier de jonction pas compris

COMIGNOLO EOLICO - AEOLIAN CAP - CHAPEAU ÉOLIEN

Cod. Femmina / Female code / Réf. Femelle	Ø
E080DPR	80
E0100DPR	100
E0120DPR	120
E0130DPR	130
E0140DPR	140
E0150DPR	150
E0180DPR	180
E0200DPR	200
E0250DPR	250
E0300DPR	300
E0350DPR	350

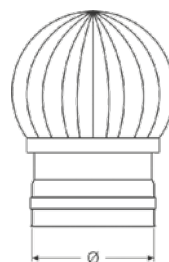

TERMINALE ORIZZONTALE DOPPIA PARETE - DOUBLE WALL HORIZONTAL ENDING PART - TERMINAL HORIZONTAL À BEC DOUBLE PAROI

Cod. / Code / Réf.	H	Ø Int. / Inte. /Intér.	Ø Est. / Exte. / Extér.
RDPGTO80	187	80	130
RDPGTO100	202	100	150
RDPGTO120	220	120	170
RDPGTO130	225	130	180
RDPGTO140	235	140	190
RDPGTO150	240	150	200
RDPGTO180	262	180	230
RDPGTO200	277	200	250
RDPGTO250	315	250	300
RDPGTO300	352	300	350
RDPGTO350	389	350	400

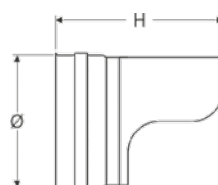

Fascetta non inclusa - Clamp not included - Collier de jonction pas compris

STAFFA DI FISSAGGIO A PARETE REGOLABILE DA 50 A 80 mm - ADJUSTABLE WALL BRACKET FROM 50 TO 80 mm - COLLIER DE FIXATION MURAL RÉGLABLE DE 50 À 80 mm

Cod. / Code / Réf.	Ø	A	B
RSTAF130	130	130	70
RSTAF150	150	148	86
RSTAF170	170	165	104
RSTAF180	180	172	110
RSTAF190	190	177	112
RSTAF200	200	185	121
RSTAF230	230	200	136
RSTAF250	250	220	155
RSTAF300	300	253	190
RSTAF350	350	290	228
RSTAF400	400	330	230

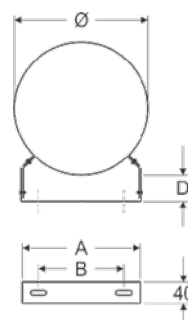

STAFFA DI FISSAGGIO A PARETE REGOLABILE DA 10 A 150 mm - ADJUSTABLE WALL BRACKET FROM 10 TO 150 mm - COLLIER DE FIXATION MURAL RÉGLABLE DE 10 À 150 mm

Cod. / Code / Réf.	Ø	A	B
RSREG130	180	117	130
RSREG150	200	134	150
RSREG170	220	135	170
RSREG180	230	170	180
RSREG190	240	176	190
RSREG200	250	179	200
RSREG230	280	195	230
RSREG250	300	175	250
RSREG300	350	245	300
RSREG350	400	320	350
RSREG400	450	376	400

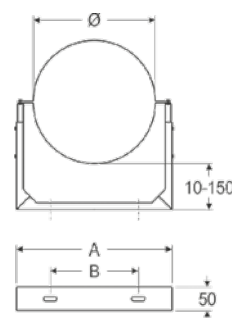

DP RAME +
DP RAME SP10

PROLUNGA PER RSTAF - RSTAF EXTENSION - RALLONGE POUR RSTAF

Cod. / Code / Réf.	L
PROLRSTAF105R	105mm
PROLRSTAF205R	205mm

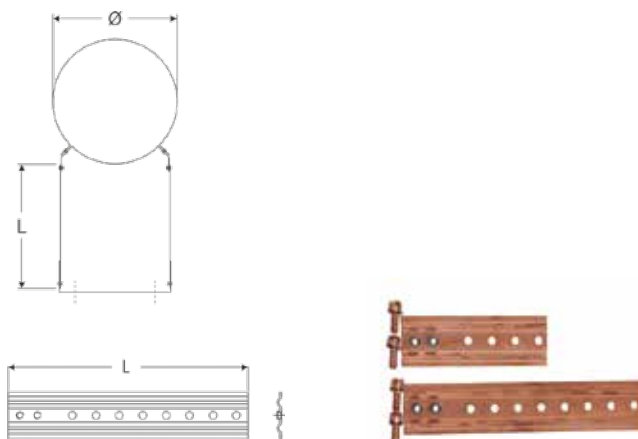

STAFFA REGOLABILE PER CORNICIONE - ADJUSTABLE ROOF BRACKET - SUPPORT RÉGLABLE POUR CORNICHE

Cod. / Code / Réf.	Ø
RSCOR130	130
RSCOR150	150
RSCOR170	170
RSCOR180	180
RSCOR190	190
RSCOR200	200
RSCOR230	230
RSCOR250	250
RSCOR300	300
RSCOR350	350

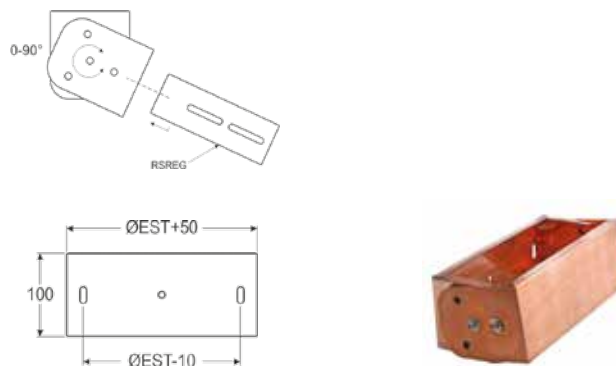

COLLARE PER CAVITIRANTI - GUY WIRE BRACKET - BRIDE DE HAUBANAGE

Cod. / Code / Réf.	Ø
RCOL130	130
RCOL150	150
RCOL170	170
RCOL180	180
RCOL190	190
RCOL200	200
RCOL230	230
RCOL250	250
RCOL300	300
RCOL350	350
RCOL400	400

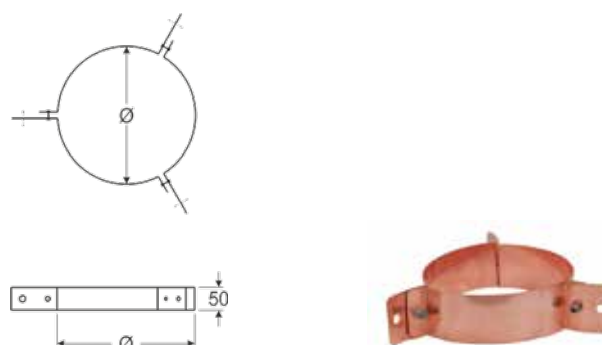

GREMBIULINA DITENUTA - STORM COLLAR - COLLET ANTI-INTEMPÉRIE

Cod. / Code / Réf.	Ø
RGRE130	130
RGRE150	150
RGRE170	170
RGRE180	180
RGRE190	190
RGRE200	200
RGRE230	230
RGRE250	250
RGRE300	300
RGRE350	350
RGRE400	400

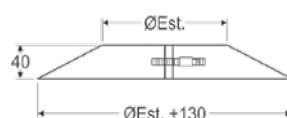

FALDALE PER TETTI INCLINATI CON BASE IN PIOMBO - FLASHING FOR SLOPED ROOFS WITH LEAD BASE - SOLIN DE TOITS PENTU AVEC BASE EN PLOMB

Cod. / Code / Réf.	Ø	ØF	A	B	H
RFI130	130	160	500	700	180
RFI150	150	180	500	700	180
RFI170	170	210	700	1000	180
RFI180	180	210	700	1000	180
RFI190	190	230	700	1000	180
RFI200	200	230	700	1000	180
RFI230	230	260	700	1000	180
RFI250	250	280	700	1000	180
RFI300	300	330	700	1000	180
RFI350	350	380	1000	1000	180
RFI400	400	430	1000	1000	120

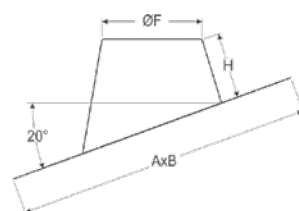

FALDALE PER TETTI PIANI - FLASHING FOR FLAT ROOFS - SOLIN DE TOITSTERRASSE

Cod. / Code / Réf.	Ø	A	B
RFP130	130	310	310
RFP150	150	330	330
RFP170	170	350	350
RFP180	180	360	360
RFP190	190	370	370
RFP200	200	380	380
RFP230	230	410	410
RFP250	250	430	430
RFP300	300	480	480
RFP350	350	490	490
RFP400	400	580	580

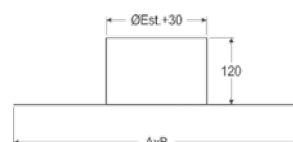

FASCETTA STRINGITUBO - CLAMP - COLLIER DE JONCTION SIMPLE

Cod. / Code / Réf.	Ø
42RFASC130	130
42RFASC150	150
42RFASC170	170
42RFASC180	180
42RFASC190	190
42RFASC200	200
42RFASC230	230
42RFASC250	250
42RFASC300	300
42RFASC350	350
42RFASC400	400



GUARNIZIONE - GASKET - JOINT D'ÉTANCHÉITÉ

Cod. / Code / Réf. H12	Cod. / Code / Réf. H9	Ø
G3L80	G3L80H9	80
G3L100	G3L100H9	100
G3L120	G3L120H9	120
G3L130	G3L130H9	130
G3L140	G3L140H9	140
G3L150	G3L150H9	150
G3L180	G3L180H9	180
G3L200	G3L200H9	200
G3L250	G3L250H9	250
G3L300	G3L300H9	300
G3L350	G3L350H9	350
G3L400	G3L400H9	400
G3L450	G3L450H9	450
G3L500	G3L500H9	500



DP RAME SP.10 - DOUBLE WALL COPPER TH.10 - CUIVRE DOUBLE PAROI ÉP.10

ELEMENTO LINEARE - STRAIGHT ELEMENT - LONGUEUR DROITE

Articoli imballati singolarmente / One item boxes / Articles emballés séparément

Lunghezza / Length / Longueur: 1000 mm

Cod. / Code / Réf.	Ø Interno / Internal / Intérieur	Ø Esterno / External / Extérieur
10RDPG80X1000	*80	100
10RDPG100X1000	*100	120
10RDPG120X1000	*120	140
10RDPG130X1000	*130	150

Lunghezza / Length / Longueur: 500 mm

10RDPG80X500	*80	100
10RDPG100X500	*100	120
10RDPG120X500	*120	140
10RDPG130X500	*130	150

Lunghezza / Length / Longueur: 250 mm

10RDPG80X250	*80	100
10RDPG100X250	*100	120
10RDPG120X250	*120	140
10RDPG130X250	*130	150

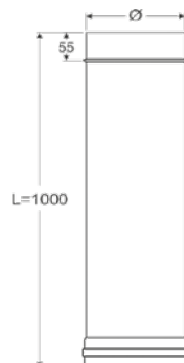

Diametri differenti su richiesta - Custom diameters upon request - Diamètres différents sur demande

CURVA 90° - 90° ELBOW - COUDE À 90°

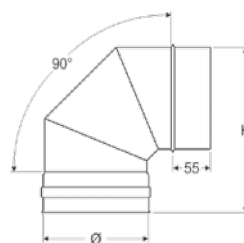
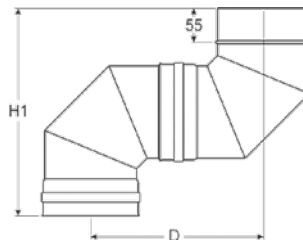

Cod. / Code / Réf.	H	H1	D	N° SET	Ø Int. / Inte. / Intér.	Ø Est. / Exte. / Extér.
10RDPGC80/90	228	356	301	3	*80	100
10RDPGC100/90	248	376	321	3	*100	120
10RDPGC120/90	268	396	341	3	*120	140
10RDPGC130/90	278	406	351	3	*130	150



Diametri differenti su richiesta - Custom diameters upon request - Diamètres différents sur demande

* **Guarnizione e fascetta stringitubo incluse** / gasket and clamp included / joint d'étanchéité et collier de jonction compris

DP RAME +
DP RAME SP10

CURVA 45° - 45° ELBOW - COUDE À 45°

Cod. / Code / Réf.	H	H1	H2	D	D1	N° SET	Ø Int. / Inte. / Intér.	Ø Est. / Exte. / Extér.
10RDPGC80/45	128	206	295	69	99	2	*80	100
10RDPGC100/45	132	225	319	74	109	2	*100	120
10RDPGC120/45	132	238	332	77	115	2	*120	140
10RDPGC130/45	151	285	397	90	142	2	*130	150

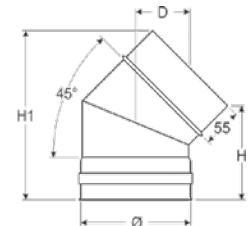
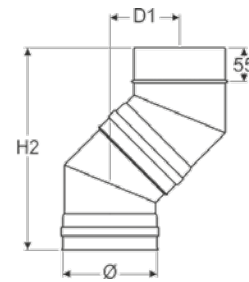

Diametri differenti su richiesta - Custom diameters upon request - Diamètres différents sur demande

T 90° STACCO MONO - 90° TEE WITH SINGLE WALL CENTRAL FITTING - TÉ À 90° AVEC RACCORD HORIZONTAL SIMPLE PAROI

Cod. / Code / Réf.	H	H1	Ø Int. / Inte. / Intér.	Ø Est. / Exte. / Extér.
10RDPGT80/90MP	245	120	*80	100
10RDPGT100/90MP	255	125	*100	120
10RDPGT120/90MP	315	155	*120	140
10RDPGT130/90MP	315	155	*130	150

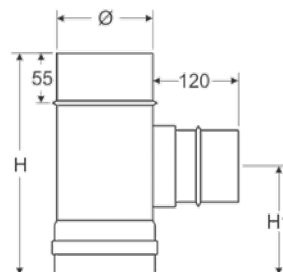

Diametri differenti su richiesta. Specificare M o F - Custom diameters upon request. Indicate M or F - Diamètres différents sur demande. Indiquer M ou F

T 90° STACCO DOPPIA - 90° TEE WITH DOUBLE WALL CENTRAL FITTING - TÉ À 90° AVEC RACCORD HORIZONTAL DOUBLE PAROI

Cod. / Code / Réf.	H	H1	Ø Int. / Inte. / Intér.	Ø Est. / Exte. / Extér.
10RDPGT80/90	245	120	*80	100
10RDPGT100/90	255	125	*100	120
10RDPGT120/90	315	155	*120	140
10RDPGT130/90	315	155	*130	150

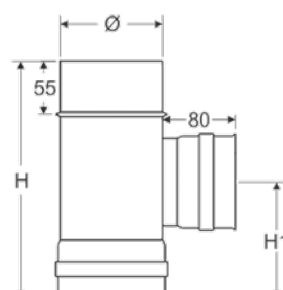

Diametri differenti su richiesta - Custom diameters upon request - Diamètres différents sur demande

T 90° STACCO RIDOTTO Ø 80 MONO - 90° REDUCING TEE TO Ø 80 SINGLE WALL - TÉ À 90° REDUIT SIMPLE PAROI Ø 80

Cod. / Code / Réf.	Ø Int. / Inte. /Intér.	Ø Est. / Exté. /Extér.
10RDPGTR100-80MP	*100	120
10RDPGTR120-80MP	*120	140
10RDPGTR130-80MP	*130	150

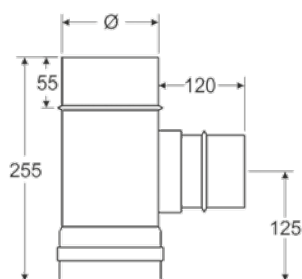

Diametri differenti su richiesta. Specificare M o F - Custom diameters upon request. Indicate M or F - Diamètres différents sur demande. Indiquer M ou F

T 90° STACCO RIDOTTO Ø 80 DOPPIA - 90° REDUCING TEE TO Ø 80 DOUBLE WALL - TÉ À 90° REDUIT DOUBLE PAROI Ø 80

Cod. / Code / Réf.	Ø Int. / Inte. /Intér.	Ø Est. / Exté. /Extér.
10RDPGTR100-80	*100	120
10RDPGTR120-80	*120	140
10RDPGTR130-80	*130	150

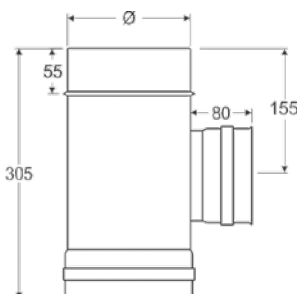

Diametri differenti su richiesta - Custom diameters upon request - Diamètres différents sur demande

MODULO DI ISPEZIONE CON TAPPO TONDO - ELEMENT WITH ROUND INSPECTION DOOR - ÉLÉMENT D'INSPECTION AVEC TRAPPE DE VISITE RONDE

Cod. / Code / Réf.	H	Øi	Ø Int. / Inte. /Intér.	Ø Est. / Exté. /Extér.
10RDPGISP80/90	210	80	*80	100
10RDPGISP100/90	245	80	*100	120
10RDPGISP120/90	245	80	*120	140
10RDPGISP130/90	245	80	*130	150

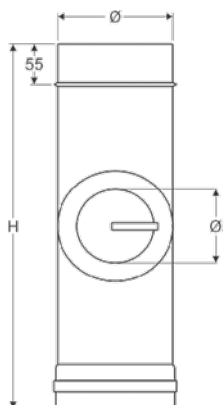

Diametri differenti su richiesta - Custom diameters upon request - Diamètres différents sur demande

SUPPORTO A MURO - WALL SUPPORT - SUPPORT MURAL

Cod. / Code / Réf.	Ø Int. / Inte. /Intér.	Ø Est. / Exte. / Extér.
10RDPGSMU80	*80	100
10RDPGSMU100	*100	120
10RDPGSMU120	*120	140
10RDPGSMU130	*130	150

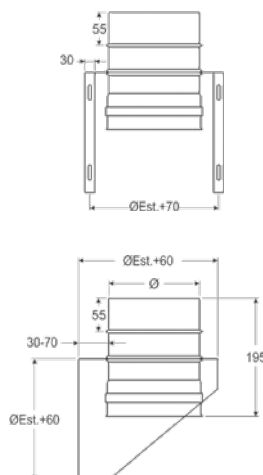

Diametri differenti su richiesta - Custom diameters upon request - Diamètres différents sur demande

ATTRAVERSAMENTO SOLAIO - INTERMEDIATE ANCHOR PLATE - MODULE DE TRAVERSEMENT DE SOL

Cod. / Code / Réf.	Ø Int. / Inte. /Intér.	Ø Est. / Exte. / Extér.
10RDPGSOL80	*80	100
10RDPGSOL100	*100	120
10RDPGSOL120	*120	140
10RDPGSOL130	*130	150

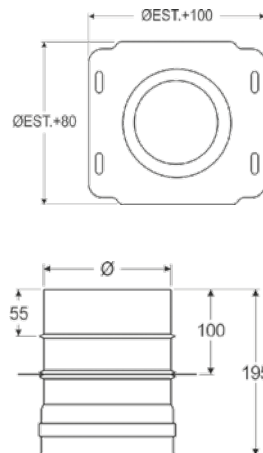

Diametri differenti su richiesta - Custom diameters upon request - Diamètres différents sur demande

RACCORDO MONO-DOPPIA - SINGLE-DOUBLE WALL ADAPTER - RACCORD SIMPLE-DOUBLE PAROI

Cod. Maschio / Male code / Réf. Mâle	Cod. Femmina / Female code / Réf. Femelle	H	Ø Int. / Inte. / Intér.	Ø Est. / Exte. / Extér.
10DPGDM80M	10DPGDM80F	170	*80	100
10DPGDM100M	10DPGDM100F	170	*100	120
10DPGDM120M	10DPGDM120F	170	*120	140
10DPGDM130M	10DPGDM130F	170	*130	150

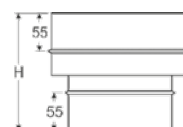
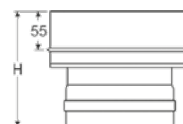

Diametri differenti su richiesta - Custom diameters upon request - Diamètres différents sur demande

RACCORDO DOPPIA-MONO - DOUBLE-SINGLE WALL ADAPTER - RACCORD DOUBLE-SIMPLE PAROI

Cod. Maschio / Male code / Réf. Mâle	Cod. Femmina / Female code / Réf. Femelle	H	Ø Int. / Inte. / Intér.	Ø Est. / Exte. / Extér.
10DPGMD80M	10DPGMD80F	170	*80	100
10DPGMD100M	10DPGMD100F	170	*100	120
10DPGMD120M	10DPGMD130F	170	*120	140
10DPGMD130M	10DPGMD160F	170	*130	150

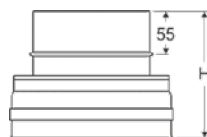

Diametri differenti su richiesta - Custom diameters upon request - Diamètres différents sur demande

RACCOGLI CONDENSA - DRAIN PLUG - BOUCHON DE CONDENSATION

Cod. / Code / Réf.	Ø Int. / Inte. /Intér.	Ø Est. / Exte. / Extér.
10RDPGRC80	*80	100
10RDPGRC100	*100	120
10RDPGRC120	*120	140
10RDPGRC130	*130	150

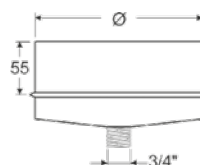

Diametri differenti su richiesta - Custom diameters upon request - Diamètres différents sur demande

COMIGNOLO CINESE - CHINESE CAP - CHAPEAU CHINOIS

Cod. / Code / Réf.	H	A	He	Ø Int. / Inte. /Intér.	Ø Est. / Exte. / Extér.
10RDPGCIN80	205	230	70	80	100
10RDPGCIN100	205	265	70	100	120
10RDPGCIN120	210	265	75	120	140
10RDPGCIN130	225	320	90	130	150

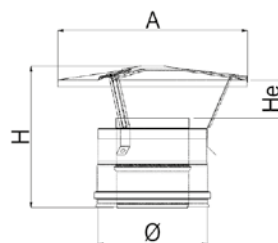

Diametri differenti su richiesta - Custom diameters upon request - Diamètres différents sur demande
Fascetta non inclusa - Clamp not included - Collier de jonction pas compris

COMIGNOLO ANTIVENTO - WINDPROOF CAP - CHAPEAU ANTI-INTEMPÉRIE

Cod. / Code / Réf.	H	A	hF	Ø Int. / Inte. /Intér.	Ø Est. / Exte. / Extér.
10RDPGAV80	240	185	165	80	100
10RDPGAV100	240	220	165	100	120
10RDPGAV120	260	260	200	120	140
10RDPGAV130	280	300	200	130	150

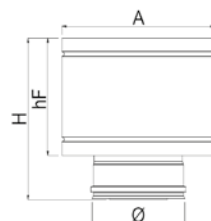

Diametri differenti su richiesta - Custom diameters upon request - Diamètres différents sur demande
Fascetta non inclusa - Clamp not included - Collier de jonction pas compris

COMIGNOLO TORRINO - TOWER CAP - CHAPEAU DONJON

Cod. / Code / Réf.	H	A	hL	N° CONI	Ø Int. / Inte. /Intér.	Ø Est. / Exte. / Extér.
10RDPGTOR80	180	130	20	3	80	100
10RDPGTOR100	215	150	20	4	100	120
10RDPGTOR120	220	180	22	4	120	140
10RDPGTOR130	230	180	22	4	130	150

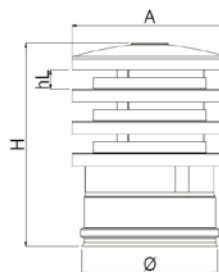

Diametri differenti su richiesta - Custom diameters upon request - Diamètres différents sur demande
Fascetta non inclusa - Clamp not included - Collier de jonction pas compris

COMIGNOLO TRONCO/CONICO - CONE TERMINAL - CÔNE DE FINITION

Cod. / Code / Réf.	Ø Int. / Inte. /Intér.	Ø Est. / Exte. / Extér.
10RDPGTC80	80	100
10RDPGTC100	100	120
10RDPGTC120	120	140
10RDPGTC130	130	150

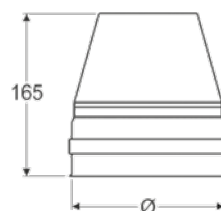

Diametri differenti su richiesta - Custom diameters upon request - Diamètres différents sur demande
Fascetta non inclusa - Clamp not included - Collier de jonction pas compris

STAFFA DI FISSAGGIO A PARETE REGOLABILE DA 50 A 80 mm - ADJUSTABLE WALL BRACKET FROM 50 TO 80 mm - COLLIER DE FIXATION MURAL RÉGLABLE DE 50 À 80 mm

Cod. / Code / Réf.	Ø	A	B	D
RSTAF100	100	114	67	50-80
RSTAF120	120	128	68	50-80
RSTAF140	140	145	85	50-80
RSTAF150	150	148	86	50-80

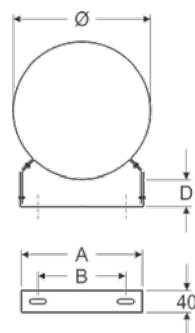

STAFFA DI FISSAGGIO A PARETE REGOLABILE DA 10 A 150 mm - ADJUSTABLE WALL BRACKET FROM 10 TO 150 mm - COLLIER DE FIXATION MURAL RÉGLABLE DE 10 À 150 mm

Cod. / Code / Réf.	Ø	A	B
RSREG100	100	149	94
RSREG120	120	163	103
RSREG140	140	200	134
RSREG150	150	230	170

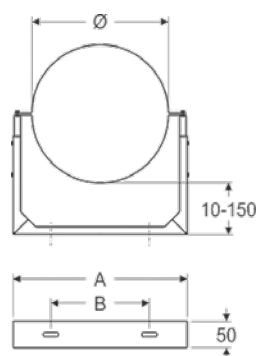

PROLUNGA PER RSTAF - RSTAF EXTENSION - RALLONGE POUR RSTAF

Cod. / Code / Réf.	€/pz	L
PROLRSTAF105R	17,50	105mm
PROLRSTAF205R	23,20	205mm

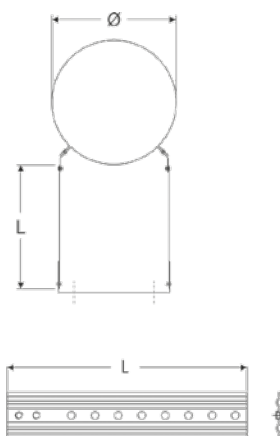

FALDALE PERTETTI INCLINATI CON BASE IN PIOMBO - FLASHING FOR SLOPED ROOFS WITH LEAD BASE - SOLIN DE TOIT PENTU AVEC BASE EN PLOMB

Cod. / Code / Réf.	Ø	ØF	A	B	H
RFI100	100	130	500	700	180
RFI120	120	160	500	700	180
RFI140	140	180	500	700	180
RFI150	150	180	500	700	180

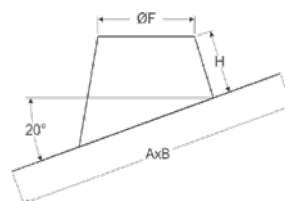

FALDALE PERTETTI PIANI - FLASHING FOR FLAT ROOFS - SOLIN TOITSTERRASSE

Cod. / Code / Réf.	Ø	A	B
RFP100	100	300	300
RFP120	120	310	310
RFP140	140	330	330
RFP150	150	330	330

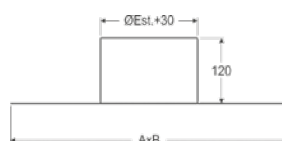

GREMBIULINA DITENUTA - STORM COLLAR - COLLET ANTI-INTEMPÉRIE

Cod. / Code / Réf.	Ø
RGRE100	100
RGRE120	120
RGRE140	140
RGRE150	150

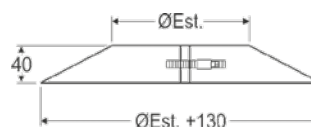

FASCETTA STRINGITUBO - CLAMP - COLLIER DE JONCTION SIMPLE

Cod. / Code / Réf.	Ø
RFASC100	100
RFASC120	120
RFASC140	140
RFASC150	150

